



Design Example Report

Title	10W Compact Power Supply using TOP245R
Specification	Input: 90 – 300 VAC Output: 6V / 1.67A
Application	Water Purifier
Author	Power Integrations Applications Department
Document Number	DER-107
Date	October 26, 2005
Revision	1.0

Summary and Features

- 66kHz operation to reduce switching losses in **TOPSwitch-GX**, reduce standby power consumption and reduce burden on input EMI Filter
- Low profile EFD20 ESHEILD™ transformer construction
- Simple input π -filter
- No Y-cap No X-cap
- 450 VDC input capacitors for increased reliability for continuous 300 V_{RMS} operation
- No heat sink design - D²PAK **TOPSwitch-GX** and D-PAK output rectifier
- 10 W (continuous) / 18 W (peak) in 1.6 X 2.5 X 1”

The products and applications illustrated herein (including circuits external to the products and transformer construction) may be covered by one or more U.S. and foreign patents or potentially by pending U.S. and foreign patent applications assigned to Power Integrations. A complete list of Power Integrations' patents may be found at www.powerint.com.

Table Of Contents

1	Introduction.....	3
2	Power Supply Specification.....	4
3	Schematic.....	5
4	Circuit Description	6
4.1	Input EMI Filtering	6
4.2	TOPSwitch Primary.....	6
4.3	Output Rectification.....	6
4.4	Output Feedback.....	6
5	PCB Layout	7
6	Bill Of Materials	8
7	Transformer Specification.....	9
7.1	Electrical Diagram	9
7.2	Electrical Specifications.....	9
7.3	Materials.....	9
7.4	Transformer Build Diagram	10
7.5	Transformer Construction.....	10
8	PIXL Transformer Spreadsheet.....	11
9	Performance Data	15
9.1	Efficiency.....	15
9.2	No-load Input Power.....	15
9.3	Regulation	16
9.3.1	Load.....	16
9.3.2	Line	16
10	Waveforms.....	17
10.1	Drain Voltage and Current, Normal Operation	17
10.2	Output Voltage Start-up Profile at Full Load.....	17
10.3	Drain Voltage and Current Start-up Profile.....	18
10.4	Load Transient Response (Load Step).....	19
10.5	Output Ripple Measurements.....	20
10.5.1	Ripple Measurement Technique	20
10.5.2	Measurement Results	21
11	Control Loop Measurements.....	22
11.1	120 VAC Maximum and 3A Load	22
11.2	240 VAC Maximum and 3A Load	23
12	Conducted EMI	24
13	Revision History.....	25

Important Notes:

Although this board is designed to satisfy safety isolation requirements, the engineering prototype has not been agency approved. Therefore, all testing should be performed using an isolated source to provide power to the prototype board.

Design Reports contain a power supply design specification, schematic, bill of materials, and transformer documentation. Performance data and typical operation characteristics are included. Typically only a single prototype has been built.



1 Introduction

This document is an engineering report describing a universal input 6 V / 10 W power supply utilizing a TOP245R. This power supply is intended to be used in a compact adapter for a water purification application. This supply has been design to operate at 300 VAC input continuously as well as provide a peak output current of 3 A for two minutes.

The document contains the power supply specification, schematic, bill-of-materials, transformer documentation, printed circuit layout, and performance data.

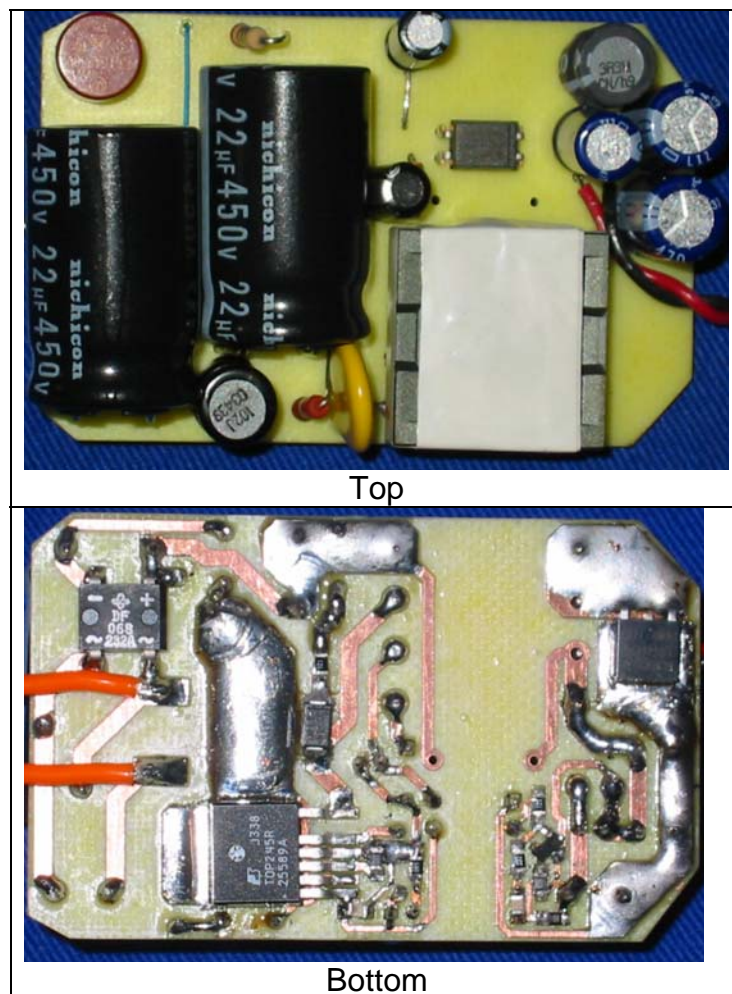

Figure 1 – Populated Circuit Board Photograph

2 Power Supply Specification

Description	Symbol	Min	Typ	Max	Units	Comment
Input						
Voltage	V_{IN}	90		300	VAC	2 Wire – no P.E.
Frequency	f_{LINE}	47	50/60	64	Hz	
No-load Input Power (240 VAC)				0.5	W	
Output						
Output Voltage 1	V_{OUT1}		6		V	± 5% 20 MHz bandwidth
Output Ripple Voltage 1	$V_{RIPPLE1}$		100		mV	
Output Current 1	I_{OUT1}		1.67		A	
Total Output Power						
Continuous Output Power	P_{OUT}			10	W	2 minute duration
Peak Output Power	P_{OUT_PEAK}			18	W	
Efficiency	η	75			%	Measured at P_{OUT} (10 W), 25 °C
Environmental						
Conducted EMI		Meets CISPR22B / EN55022B				1.2/50 μ s surge, IEC 1000-4-5, Series Impedance: Differential Mode: 2 Ω Common Mode: 12 Ω
Safety		Designed to meet IEC950, UL1950 Class II				
Surge		4			kV	
Surge		4			kV	100 kHz ring wave, 500 A short circuit current, differential and common mode
Ambient Temperature	T_{AMB}	0		40	°C	Free convection, sea level



3 Schematic

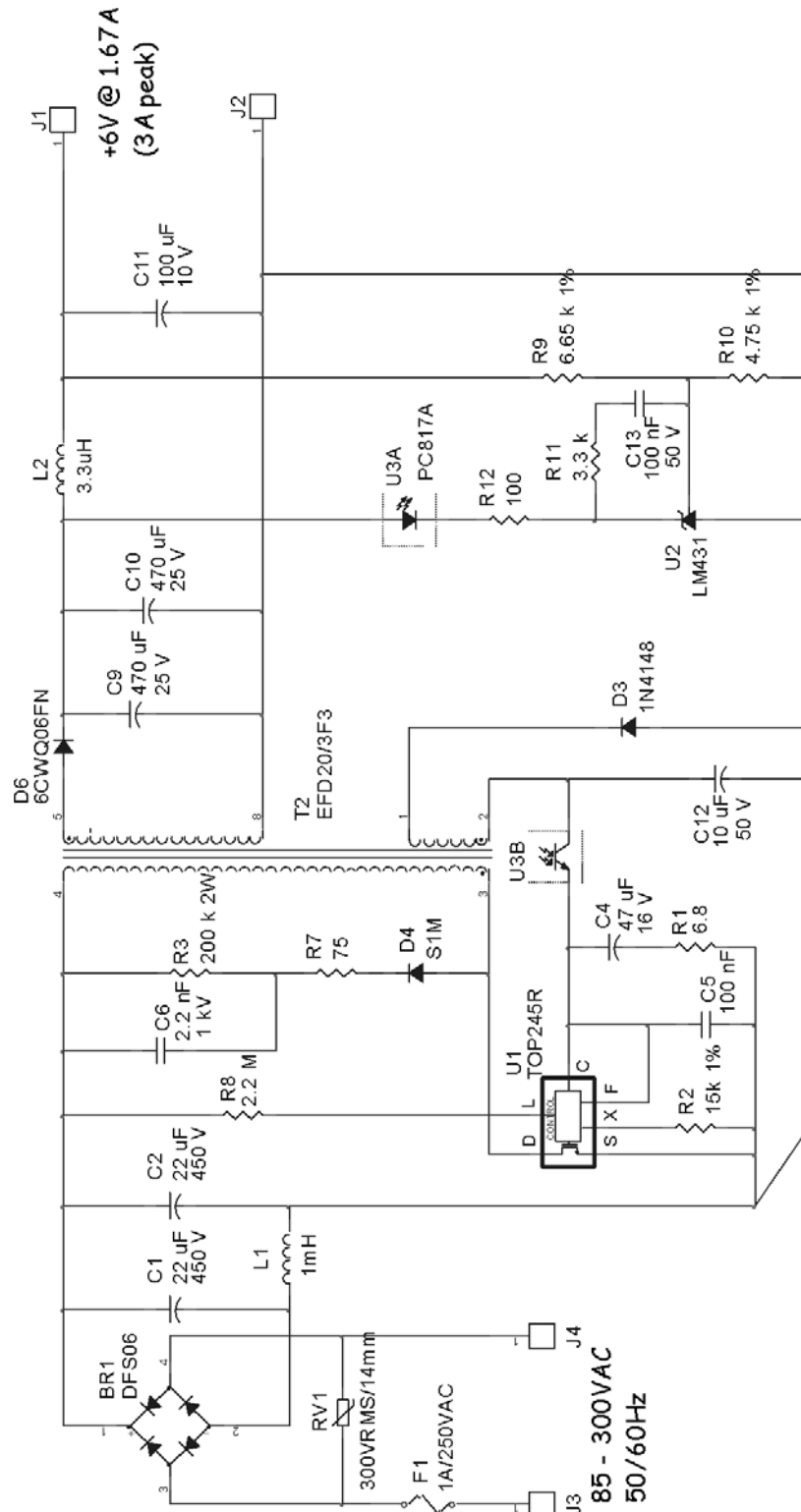

Figure 2 – Schematic



4 Circuit Description

The schematic in Figure 2 shows an off-line Flyback converter using the TOP245R. The circuit is designed for 90 VAC to 300 VAC input and 6 V, 1.67 A output, with a transient load requirement of 3 A for 2 minutes in duration.

4.1 Input EMI Filtering

Capacitor C1, C2 and L1 form in input p-filter for differential-mode conducted EMI. Common-mode conducted EMI is reduced with the ESHIELD winding technique employed in the transformer construction. A input X-capacitor and a Y-capacitor to bridge the isolation barrier are not required, due to the ESHIELD transformer construction and frequency dithering of the **TOPSwitch-GX**.

4.2 TOPSwitch Primary

Rectifier bridge BR1 and C1, C2 provide a high voltage DC BUS for the primary circuitry. The DC rail is applied to the primary winding of T2. The other side of the transformer primary is driven by the integrated MOSFET in U1. Diode D4, R7, R3 and C6 clamp leakage spikes generated when the MOSFET in U1 switches off. Resistor R8 sets the low-line turn-on threshold to approximately 69 VAC, and also sets the over-voltage shutdown level to approximately 320 VAC. R2 sets the U1 current limit to approximately 75% of its nominal value. This limits the output power delivered during fault conditions. C5 bypasses the U1 CONTROL pin. C4 has 3 functions. It provides the energy required by U1 during startup, sets the auto-restart frequency during fault conditions, and also acts to roll off the gain of U1 as a function of frequency. R1 adds a zero to stabilize the power supply control loop. Diode D3 and C12 provide rectified and filtered bias power for U3 and U1. The Frequency pin (F-pin) of U1 is tied to the Control pin (C-pin) to set the operating frequency of the U1 to 66kHz.

4.3 Output Rectification

The output of T2 is rectified and filtered by D6, C9, and C10. Inductor L2 and C11 provide additional high frequency filtering.

4.4 Output Feedback

Resistors R9 and R10 divide down the supply output voltage and apply it to the reference pin of error amplifier U2. Shunt regulator U2 drives optocoupler U3 through resistor R12 to provide feedback information to the U1 CONTROL pin. The optocoupler output also provides power to U1 during normal operating conditions.

Components C4, C13, R1, R11, and R12 all play a role in compensating the power supply control loop. Capacitor C4 rolls off the gain of U1 at relatively low frequency. Resistor R1 provides a zero to cancel the phase shift of C4. Resistor R12 sets the gain of the direct signal path from the supply output through U2 and U3. Components C13 and R11 roll off the gain of U2.



5 PCB Layout

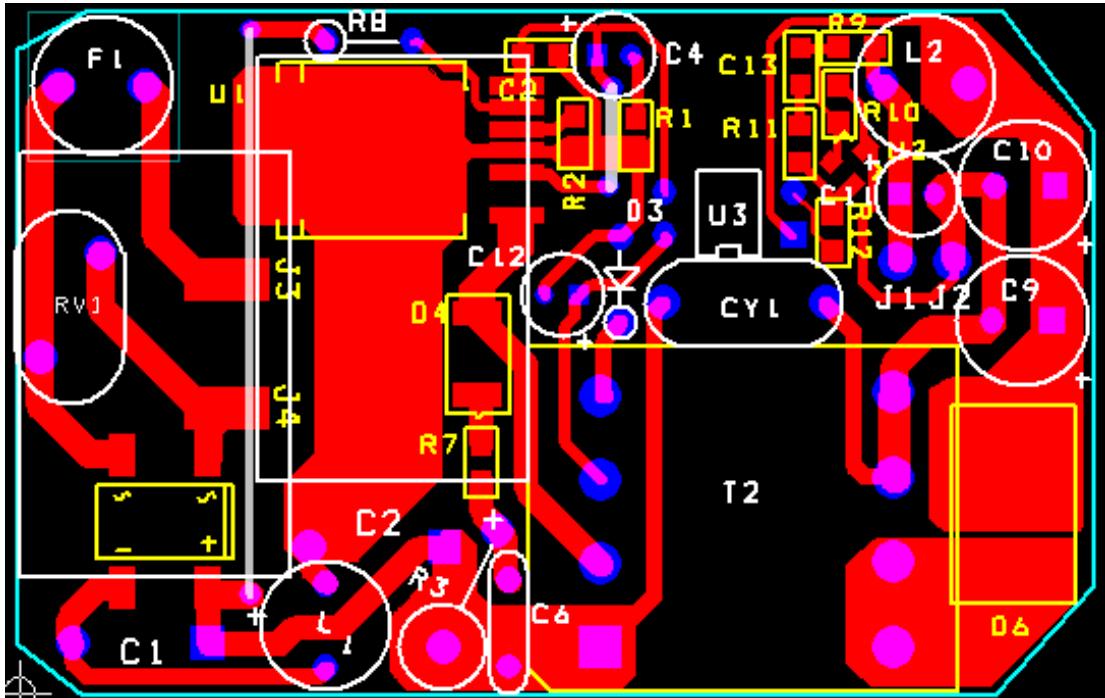

Figure 3 – Printed Circuit Layout



6 Bill Of Materials

Item	QTY	Ref Des	Description	Value	Mfg	Mfg Part Number
1	1	BR1	600 V, 1 A, Bridge Rectifier, SMD, DFS	DFS06	Vishay	DFS06
2	2	C1 C2	22 uF, 450 V, Electrolytic, 105C (16 x 25)	22 uF	Nichicon	UVZ2W220MHD
3	1	C4	47 uF, 16 V, Electrolytic, Gen. Purpose, (5 x 11)	47 uF	United Chemi-Con	KME16VB47RM5X11LL
4	2	C5 C13	100 nF, 50 V, Ceramic, X7R	100 nF	Panasonic	ECU-S1H104KBB
5	1	C6	2.2 nF, 1 kV, Disc Ceramic	2.2 nF	NIC Components Corp	NCD222K1KVY5F
6	2	C9 C10	560 uF, 25 V, Electrolytic, Very Low ESR, 29 mOhm, (8 x 20)	560 uF	Rubycon	1EZLH560K8X20
7	1	C11	100 uF, 10 V, Electrolytic, Low ESR, 500 mOhm, (5 x 11.5)	100 uF	United Chemi-Con	LXZ10VB101ME11LL
8	1	C12	10 uF, 50 V, Electrolytic, Gen. Purpose, (5 x 11)	10 uF	United Chemi-Con	KMG50VB10RM5X11LL
9	1	D3	200 V, 300 mA, Fast Switching, DO-35	BAV21	Vishay	BAV21
10	1	D4	1000 V, 1 A, Rectifier, Glass Passivated, SMA	S1M	Vishay	S1M
11	1	D6	60 V, 6 A, Schottky, SMD, DPAK	6CWQ06	IR	6CWQ06
12	1	F1	3.15 A, 250V, Slow, TR5	FUSE	Wickman	3821315041
13	1	L1	1000 uH, 0.28 A	1mH	Tokin	SBC3-102-281
14	1	L2	3.3 uH, 5.5 A, 8.5 x 11 mm	3.3uH	Toko	R622LY-3R3M
15	1	R1	6.8 R, 5%, 0805	6.8		
16	1	R2	13.7 k, 1%, 0805	13.7 k		
17	1	R3	200 k, 5%, 1 W, Metal Oxide	200 k	Yageo	RSF200JB-200K
18	1	R7	75 R, 5%, 1/8 W, Metal Film, 0805	75		
19	1	R8	2.2 M, 5%, 1/4 W, Carbon Film	2.2 M		
20	1	R9	6.65 k, 1%, 1/4 W, Metal Film, 1206	6.65 k		
21	1	R10	4.75 k, 1%, 1/4 W, Metal Film, 1206	4.75 k		
22	1	R11	3.3 k, 5%, 1/8 W, Metal Film, 0805	3.3 k		
23	1	R12	100 R, 1%, 1/8 W, Metal Film, 0805	100		
24	1	RV1	300 V, 23 J, 7 mm, RADIAL	VARISTOR	Littlefuse	V300LA4
25	1	T2	Bobbin, EFD20, Horizontal, 8 pins	BEFD20_8P	Yih-Hwa Enterprises	YW-272-03B
26	1	U1	TOPSwitch-GX, TOP245R, TO-263-7C	TOP245R	Power Integrations	TOP245R
27	1	U2	2.495 V Shunt Regulator IC, 1%, -40 to 85C, SOT23	LM431	National Semiconductor	LM431BCM
28	1	U3	Opto coupler, 35 V, CTR 80-160%, 4-DIP	PC817A	Isocom, Sharp	ISP817A, PC817X1



7 Transformer Specification

7.1 Electrical Diagram

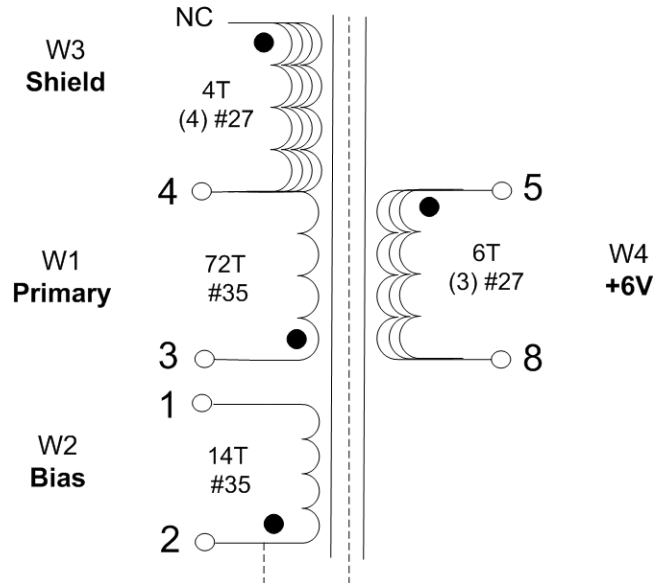

Figure 4 – Transformer Electrical Diagram

7.2 Electrical Specifications

Electrical Strength	1 second, 60 Hz, from Pins 1-4 to Pins 5-8	3000 VAC
Primary Inductance	Pins 3-4, all other windings open, measured at 100 kHz, 0.4 VRMS	606 μ H, -7/+7%
Resonant Frequency	Pins 3-4, all other windings open	800 kHz (Min.)
Primary Leakage Inductance	Pins 3-4, with Pins 5-8 shorted, measured at 100 kHz, 0.4 VRMS	100 μ H (Max.)

7.3 Materials

Item	Description
[1]	Core: EFD20/3F3 AL = 104nH/T ²
[2]	Bobbin: 8-pin
[3]	Magnet Wire: #35 AWG Heavy Build
[4]	Magnet Wire: #27 AWG Heavy Build
[5]	Tape: 3M 3mm wide
[6]	Tape, 3M
[7]	Tape, 3M
[8]	Copper tape 1.5 mil thick X 8mm wide
[9]	Varnish



7.4 Transformer Build Diagram

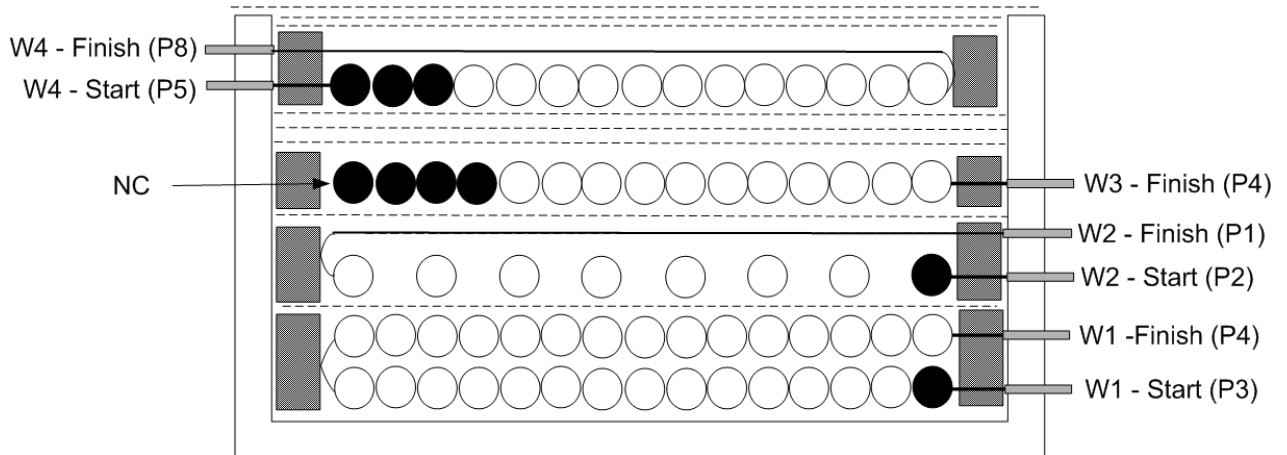

Figure 5 – Transformer Build Diagram

7.5 Transformer Construction

Bobbin Preparation	Align bobbin to have pins 1-4 facing the mandrill
Primary Margin	Apply 3 mm wide margin on either side of bobbin with item [5]. Match height of primary and bias windings.
Primary	Start at Pin 3. Wind 76 turns of item [3] in approximately 2 layers, finish on Pin 4.
Basic Insulation	Use one layer of item [6] for basic insulation.
Bias Winding	Starting at Pin 2, wind 14 turns of item [3] uniformly across bobbin width in a single layer. Finish at Pin 1.
Basic Insulation	Use one layer of item [6] for basic insulation.
Primary Margin	Apply 3 mm wide margin on either side of bobbin with item [5]. Match height of balanced shield winding.
Balanced Shield Winding	Start temporarily on pin 6. Wind 4 turns of quadrifilar item [4] uniformly across the bobbin width in a single layer. Finish on pin 4. Cut start of winding at 90-degree bend to center of bobbin window.
Reinforced Insulation	Use three layers of item [7] for reinforced insulation.
Secondary Margin	Apply 3 mm wide margin on either side of bobbin with item [5]. Match height of secondary winding.
Secondary Winding	Start at Pin 5. Wind 6 trifilar turns of item [4]. Spread turns evenly across bobbin in a single layer. Finish on Pin 8.
Outer Wrap	Wrap windings with 3 layers of tape (item [7]).
Core Preparation	Affix cores (item [1]) with tape [5].
Outer Belly band	Wrap one turn of copper tape [8] around outer core. Ensure copper tape makes contact with core halves. Solder wire from pin 2 of bobbin to copper bellyband.
Final Assembly	Wrap three layers of tape [7]. Varnish impregnate (item [9]).



8 PIXL Transformer Spreadsheet

ACDC_TOPSwitchGX_113004; Rev.2.2; Copyright Power Integrations Inc. 2004	INPUT	INFO	OUTPUT	UNIT	TOP_GX_FX_113004.xls: TOPSwitch-GX/FX Continuous/Discontinuous Flyback Transformer Design Spreadsheet
ENTER APPLICATION VARIABLES					
VACMIN	85			Volts	
VACMAX	300			Volts	Maximum AC Input Voltage
fL	50			Hertz	AC Mains Frequency
VO	6			Volts	Output Voltage
PO	18			Watts	Output Power
n	0.73				Efficiency Estimate
Z	0.5				Loss Allocation Factor
VB	15			Volts	Bias Voltage
tC	3			mSeconds	Bridge Rectifier Conduction Time Estimate
CIN	44			uFarads	Input Filter Capacitor
ENTER TOPSWITCH-GX VARIABLES					
TOP-GX	TOP245			<i>Universal</i>	<i>115 Doubled/230V</i>
Chosen Device		<i>TOP245</i>	<i>Power Out</i>	<i>60W</i>	<i>85W</i>
KI	0.8				External Ilimit reduction factor (KI=1.0 for default ILIMIT, KI <1.0 for lower ILIMIT)
ILIMITMIN			1.296	Amps	Use 1% resistor in setting external ILIMIT
ILIMITMAX			1.584	Amps	Use 1% resistor in setting external ILIMIT
Frequency (F)=132kHz, (H)=66kHz	h				Half (H) frequency option - 66kHz
fS			66000	Hertz	TOPSwitch-GX Switching Frequency: Choose between 132 kHz and 66 kHz
fSmin			61500	Hertz	TOPSwitch-GX Minimum Switching Frequency
fSmax			70500	Hertz	TOPSwitch-GX Maximum Switching Frequency
VOR	82			Volts	Reflected Output Voltage
VDS	10			Volts	TOPSwitch on-state Drain to Source Voltage
VD	0.5			Volts	Output Winding Diode Forward Voltage Drop
VDB	0.7			Volts	Bias Winding Diode Forward Voltage Drop
KP	0.9415				Ripple to Peak Current Ratio (0.4 < KRP < 1.0 : 1.0 < KDP < 6.0)
ENTER TRANSFORMER CORE/CONSTRUCTION VARIABLES					
Core Type	efd20				
Core		<i>EFD20</i>		<i>P/N:</i>	<i>EFD20-3F3</i>



<i>Bobbin</i>		<i>EFD20_BOBBIN</i>		<i>P/N:</i>	CSH-EFD20-1S-8P
AE	0.58		0.58	cm ²	Core Effective Cross Sectional Area
LE	5.7		5.7	cm	Core Effective Path Length
AL	1800		1800	nH/T ²	Ungapped Core Effective Inductance
BW	16.4		16.4	mm	Bobbin Physical Winding Width
M	3			mm	Safety Margin Width (Half the Primary to Secondary Creepage Distance)
L	2				Number of Primary Layers
NS	6				Number of Secondary Turns
DC INPUT VOLTAGE PARAMETERS					
VMIN			81	Volts	Minimum DC Input Voltage
VMAX			424	Volts	Maximum DC Input Voltage
CURRENT WAVEFORM SHAPE PARAMETERS					
DMAX			0.54		Maximum Duty Cycle
IAVG			0.30	Amps	Average Primary Current
IP			1.07	Amps	Peak Primary Current
IR			1.01	Amps	Primary Ripple Current
IRMS			0.47	Amps	Primary RMS Current
TRANSFORMER PRIMARY DESIGN PARAMETERS					
LP			606	uHenries	Primary Inductance
NP			76		Primary Winding Number of Turns
NB			14		Bias Winding Number of Turns
ALG			106	nH/T ²	Gapped Core Effective Inductance
BM			1480	Gauss	Maximum Flux Density at PO, VMIN (BM<3000)
BP			2187	Gauss	Peak Flux Density (BP<4200)
BAC			696	Gauss	AC Flux Density for Core Loss Curves (0.5 X Peak to Peak)
ur			1408		Relative Permeability of Ungapped Core
LG			0.65	mm	Gap Length (Lg > 0.1 mm)
BWE			20.8	mm	Effective Bobbin Width
OD			0.27	mm	Maximum Primary Wire Diameter including insulation
INS			0.05	mm	Estimated Total Insulation Thickness (= 2 * film thickness)
DIA			0.22	mm	Bare conductor diameter
AWG			32	AWG	Primary Wire Gauge (Rounded to next smaller standard AWG value)
CM			64	Cmils	Bare conductor effective area in circular mils
CMA		<i>Warning</i>	137	Cmils/Amp	!!!!!!! INCREASE CMA>200 (increase L(primary layers),decrease NS, larger Core)
TRANSFORMER SECONDARY DESIGN PARAMETERS (SINGLE OUTPUT EQUIVALENT)					
Lumped parameters					
ISP			13.52	Amps	Peak Secondary Current



ISRMS			5.48	Amps	Secondary RMS Current
IO			3.00	Amps	Power Supply Output Current
IRIPPLE			4.59	Amps	Output Capacitor RMS Ripple Current
CMS			1097	Cmils	Secondary Bare Conductor minimum circular mils
AWGS			19	AWG	Secondary Wire Gauge (Rounded up to next larger standard AWG value)
DIAS			0.91	mm	Secondary Minimum Bare Conductor Diameter
ODS			1.73	mm	Secondary Maximum Outside Diameter for Triple Insulated Wire
INSS			0.41	mm	Maximum Secondary Insulation Wall Thickness
VOLTAGE STRESS PARAMETERS					
VDRAIN			616	Volts	Maximum Drain Voltage Estimate (Includes Effect of Leakage Inductance)
PIVS			40	Volts	Output Rectifier Maximum Peak Inverse Voltage
PIVB			96	Volts	Bias Rectifier Maximum Peak Inverse Voltage
TRANSFORMER SECONDARY DESIGN PARAMETERS (MULTIPLE OUTPUTS)					
1st output					
VO1	6.0		6	Volts	Output Voltage
IO1	3.000		3	Amps	Output DC Current
PO1			18.00	Watts	Output Power
VD1	0.5		0.5	Volts	Output Diode Forward Voltage Drop
NS1			6.00		Output Winding Number of Turns
ISRMS1			5.484	Amps	Output Winding RMS Current
IRIPPLE1			4.59	Amps	Output Capacitor RMS Ripple Current
PIVS1			40	Volts	Output Rectifier Maximum Peak Inverse Voltage
CMS1			1097	Cmils	Output Winding Bare Conductor minimum circular mils
AWGS1			19	AWG	Wire Gauge (Rounded up to next larger standard AWG value)
DIAS1			0.91	mm	Minimum Bare Conductor Diameter
ODS1			1.73	mm	Maximum Outside Diameter for Triple Insulated Wire
2nd output					
VO2	6.0			Volts	Output Voltage
IO2	1.670			Amps	Output DC Current
PO2			10.02	Watts	Output Power
VD2	0.5			Volts	Output Diode Forward Voltage Drop
NS2			6.00		Output Winding Number of Turns



ISRMS2			3.053	Amps	Output Winding RMS Current
IRIPPLE2			2.56	Amps	Output Capacitor RMS Ripple Current
PIVS2			40	Volts	Output Rectifier Maximum Peak Inverse Voltage
CMS2			611	Cmils	Output Winding Bare Conductor minimum circular mils
AWGS2			22	AWG	Wire Gauge (Rounded up to next larger standard AWG value)
DIAS2			0.65	mm	Minimum Bare Conductor Diameter
ODS2			1.73	mm	Maximum Outside Diameter for Triple Insulated Wire



9 Performance Data

All measurements performed at room temperature, 60 Hz input frequency.

9.1 Efficiency

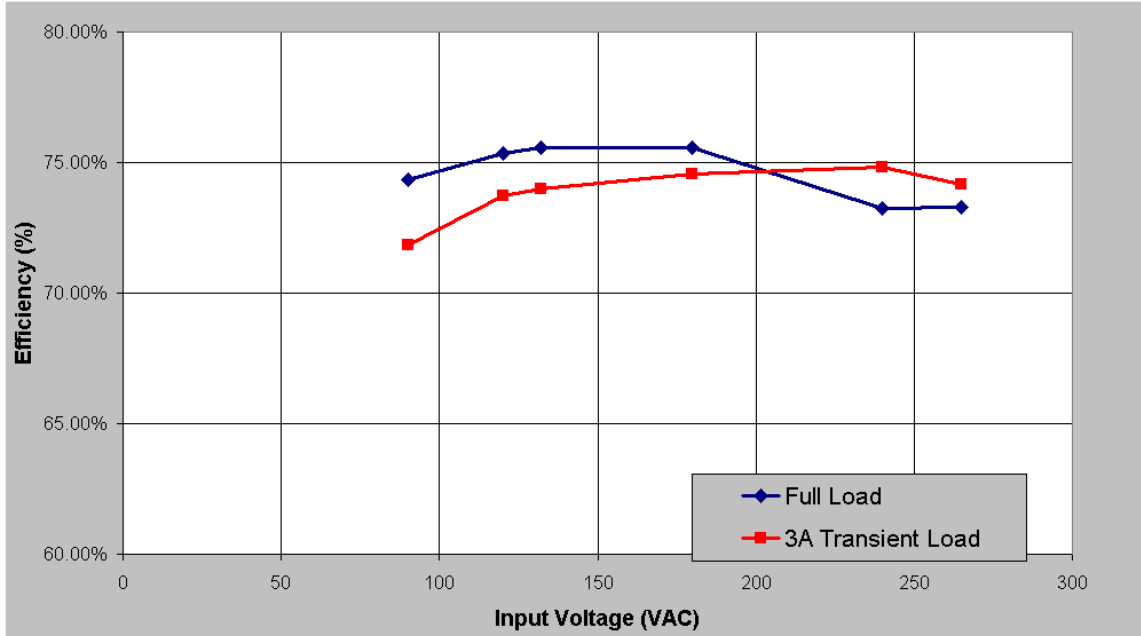

Figure 6 – Efficiency vs. Input Voltage, Room Temperature, 60 Hz.

9.2 No-load Input Power

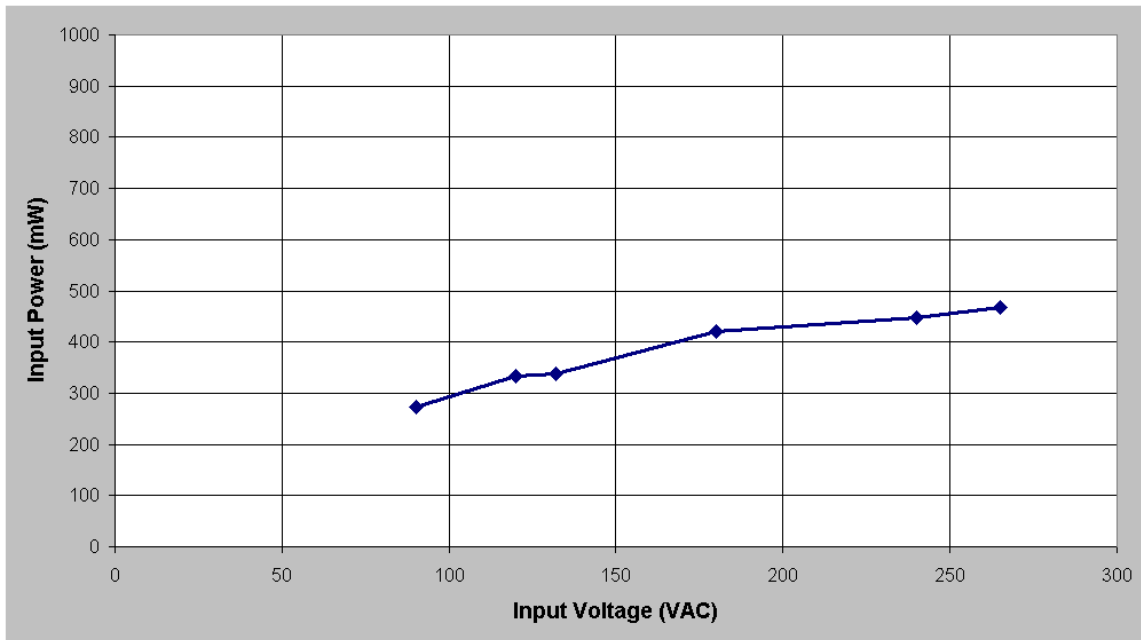

Figure 7 – Zero Load Input Power vs. Input Line Voltage, Room Temperature, 60 Hz



9.3 Regulation

9.3.1 Load

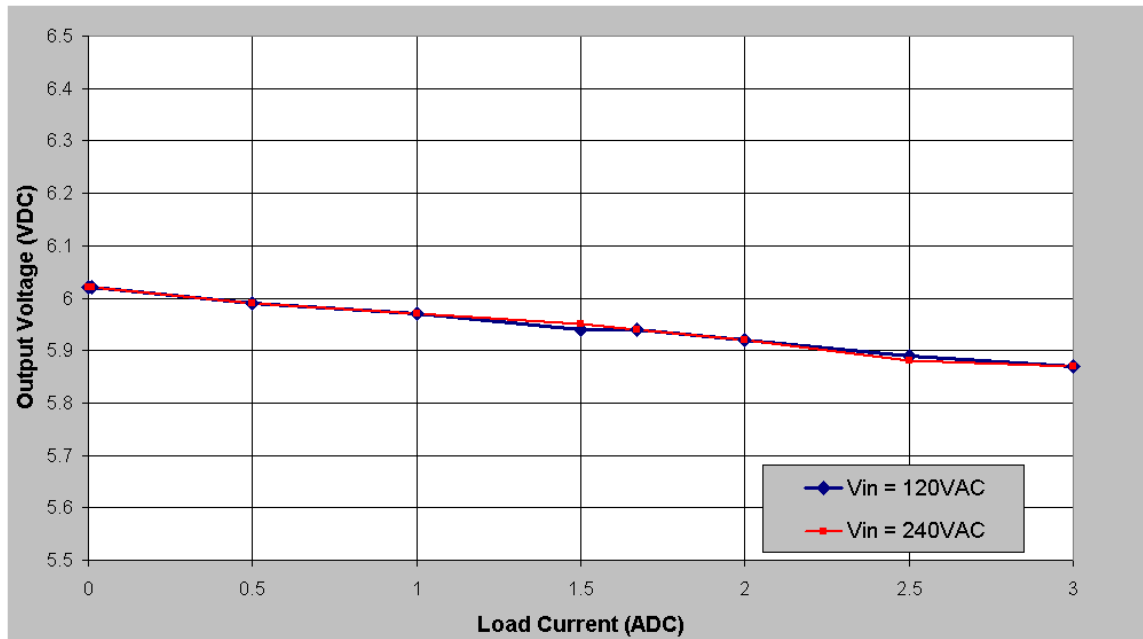

Figure 8 – Load Regulation, Room Temperature

9.3.2 Line

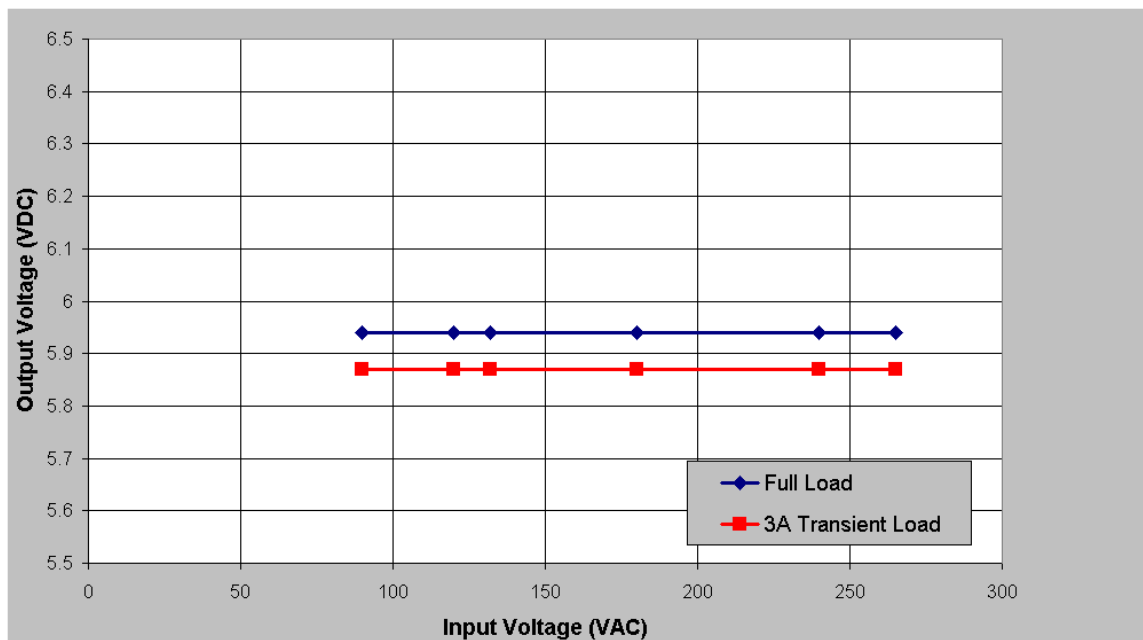

Figure 9 – Line Regulation, Room Temperature, Full Load



10 Waveforms

10.1 Drain Voltage and Current, Normal Operation

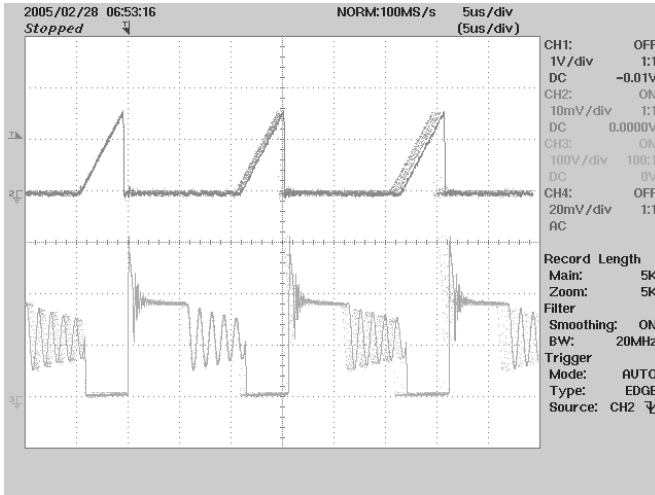

Figure 10 – 90 VAC, Full Load.
Upper: I_{DRAIN} , 0.5 A / div
Lower: V_{DRAIN} , 100 V, 2 μ s / div

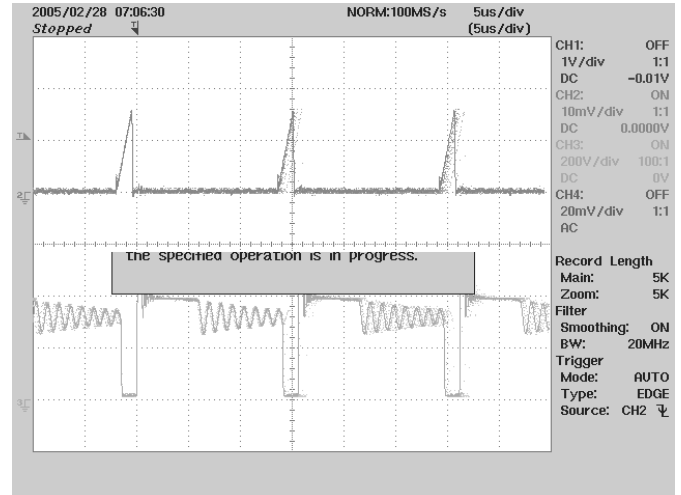

Figure 11 – 265 VAC, Full Load
Upper: I_{DRAIN} , 0.5 A / div
Lower: V_{DRAIN} , 200 V / div

10.2 Output Voltage Start-up Profile at Full Load

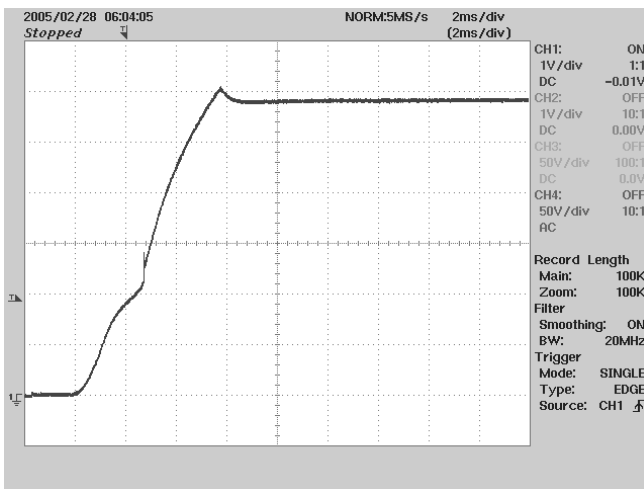

Figure 12 – Start-up Profile, 120VAC
1 V, 2 ms / div.

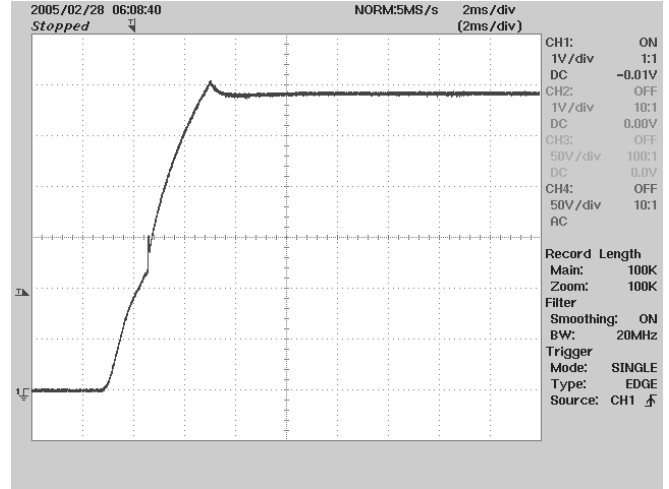

Figure 13 – Start-up Profile, 240 VAC
1 V, 2 ms / div.



10.3 Drain Voltage and Current Start-up Profile

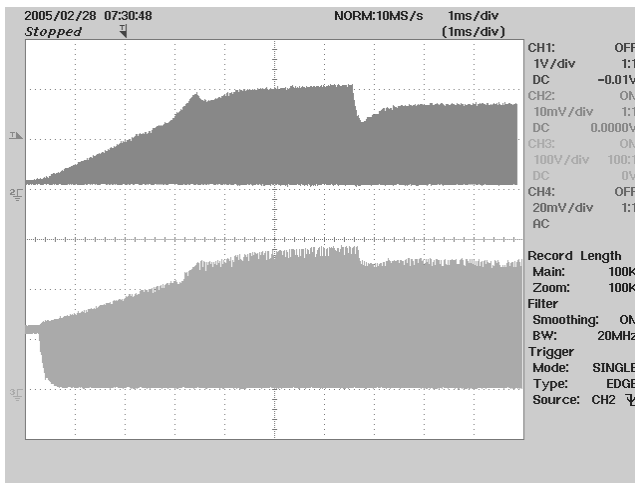

Figure 14 – 90 VAC Input and Maximum Load.
Upper: I_{DRAIN} , 0.5 A / div.
Lower: V_{DRAIN} , 100 V & 1 ms / div.

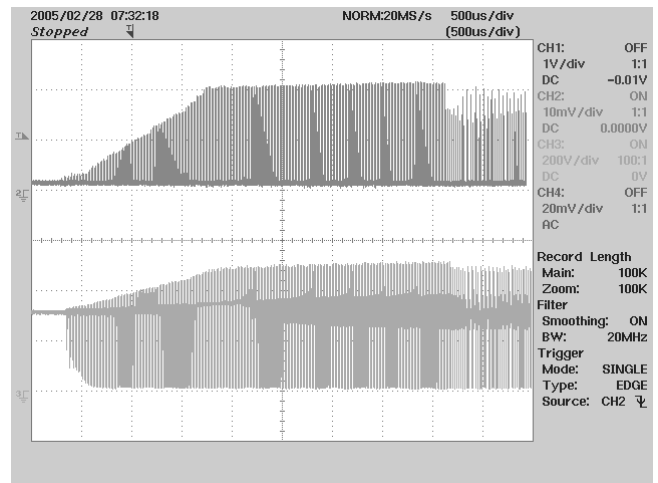

Figure 15 – 265 VAC Input and Maximum Load.
Upper: I_{DRAIN} , 0.5 A / div.
Lower: V_{DRAIN} , 200 V & 1 ms / div.



10.4 Load Transient Response (Load Step)

In the figures shown below, signal averaging was used to better enable viewing the load transient response. The oscilloscope was triggered using the load current step as a trigger source. Since the output switching and line frequency occur essentially at random with respect to the load transient, contributions to the output ripple from these sources will average out, leaving the contribution only from the load step response.

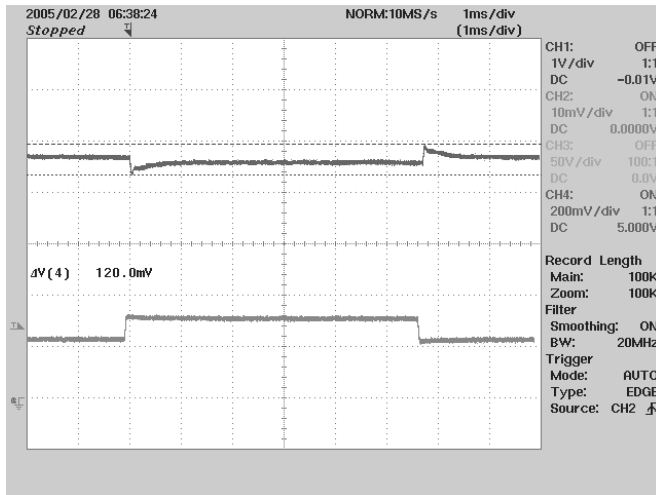

Figure 16 – Transient Response, 120 VAC, 75-100-75% Load Step.
Bottom: Load Current, 1 A/div.
Top: Output Voltage
2000 mV, 5V offset, 1ms / div.

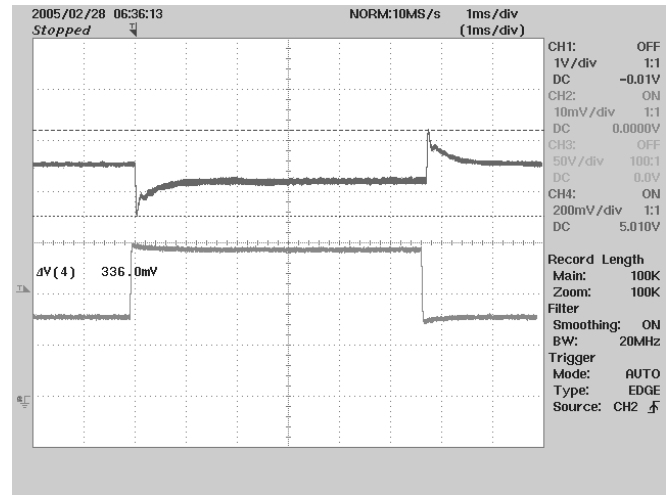

Figure 17 – Transient Response, 120 VAC, 100-180-100% Load Step
Bottom: Load Current, 1 A/ div.
Top: Output Voltage
200 mV 5V offset, 1 ms / div.



10.5 Output Ripple Measurements

10.5.1 Ripple Measurement Technique

For DC output ripple measurements, a modified oscilloscope test probe must be utilized in order to reduce spurious signals due to pickup. Details of the probe modification are provided in Figure 18 and Figure 19.

The 5125BA probe adapter is affixed with two capacitors tied in parallel across the probe tip. The capacitors include one (1) 0.1 $\mu\text{F}/50\text{ V}$ ceramic type and one (1) 1.0 $\mu\text{F}/50\text{ V}$ aluminum electrolytic. **The aluminum electrolytic type capacitor is polarized, so proper polarity across DC outputs must be maintained (see below).**

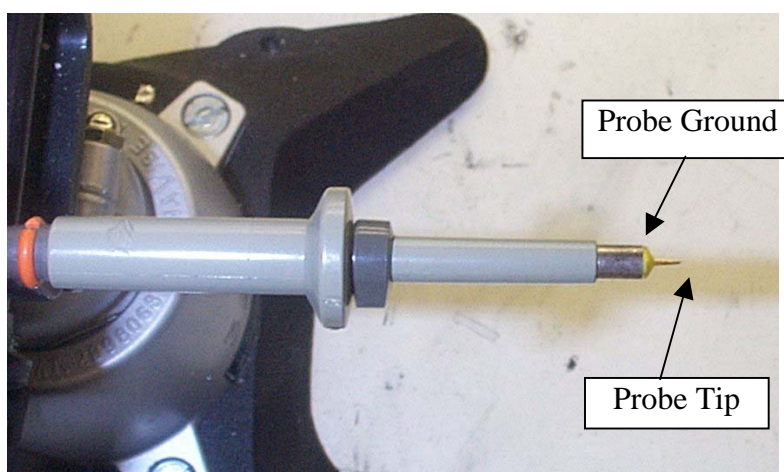

Figure 18 – Oscilloscope Probe Prepared for Ripple Measurement. (End Cap and Ground Lead Removed)



Figure 19 – Oscilloscope Probe with Probe Master 5125BA BNC Adapter. (Modified with wires for probe ground for ripple measurement, and two parallel decoupling capacitors added)

10.5.2 Measurement Results

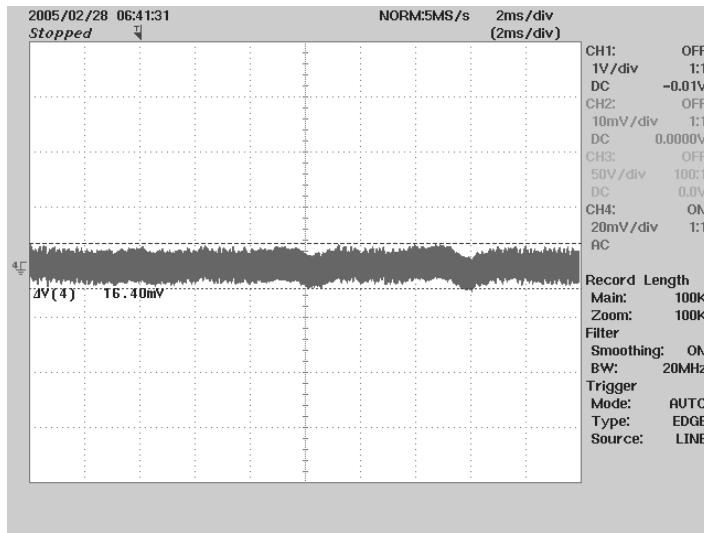

Figure 20 – Ripple, 120VAC, Full Load.
2 ms, 20 mV / div

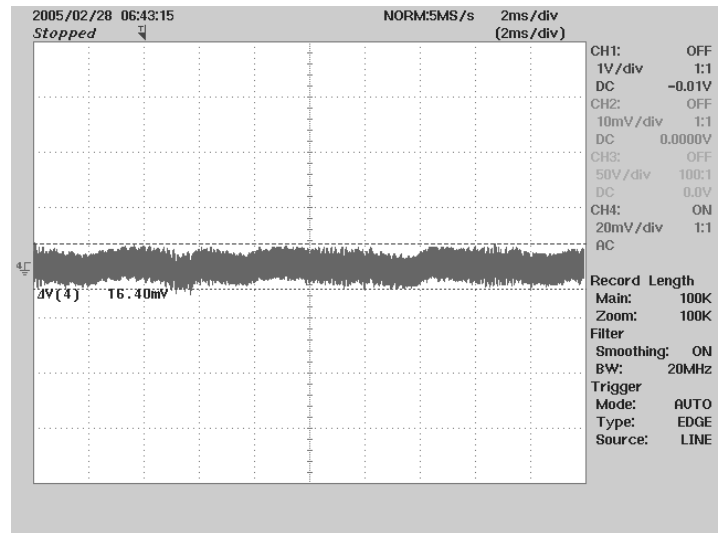

Figure 21 – Ripple, 240VAC, Full Load.
2 ms, 20 mV / div



11 Control Loop Measurements

11.1 120 VAC Maximum and 3A Load

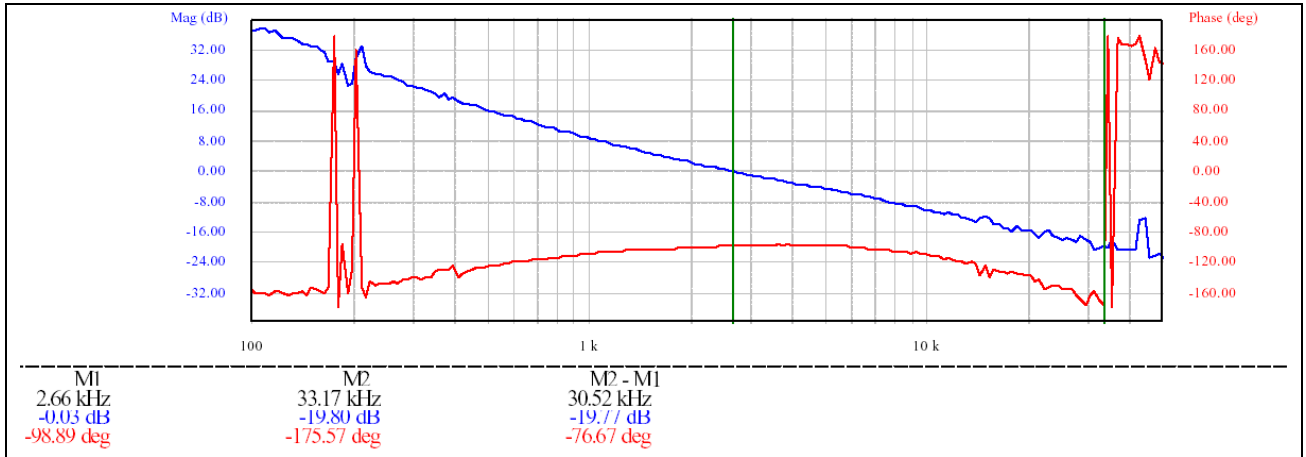

Figure 22 – Gain-Phase Plot, 120 VAC, Maximum Steady State Load
 Vertical Scale: Gain = 8 dB/div, Phase = 40 °/div.
 Crossover Frequency = 2.66 kHz Phase Margin = 88.11°

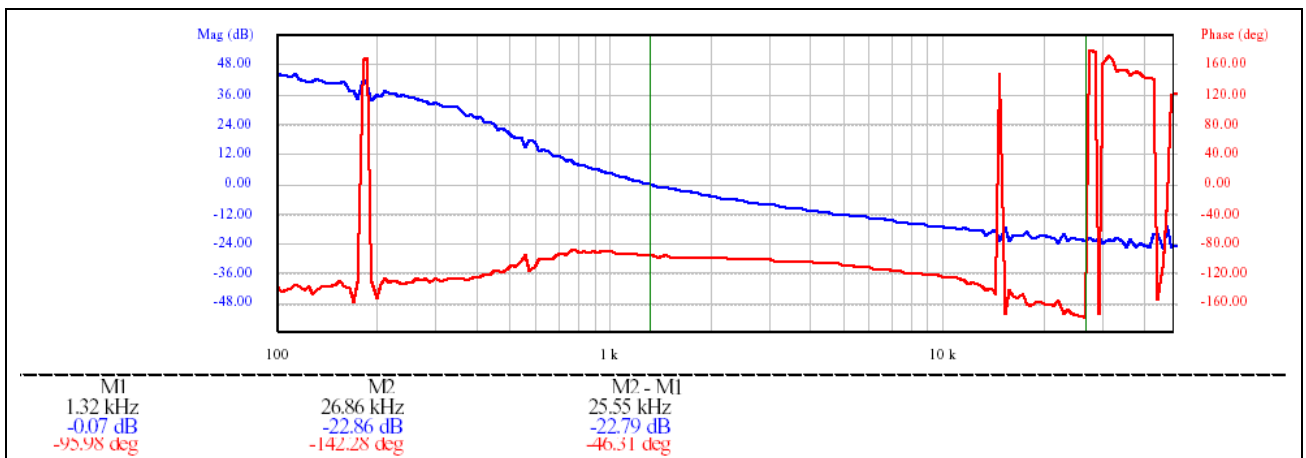

Figure 23 – Gain-Phase Plot, 120 VAC, 3A Load
 Vertical Scale: Gain = 12 dB/div, Phase = 40 °/div.
 Crossover Frequency = 1.32 kHz Phase Margin = 84.02°



11.2 240 VAC Maximum and 3A Load

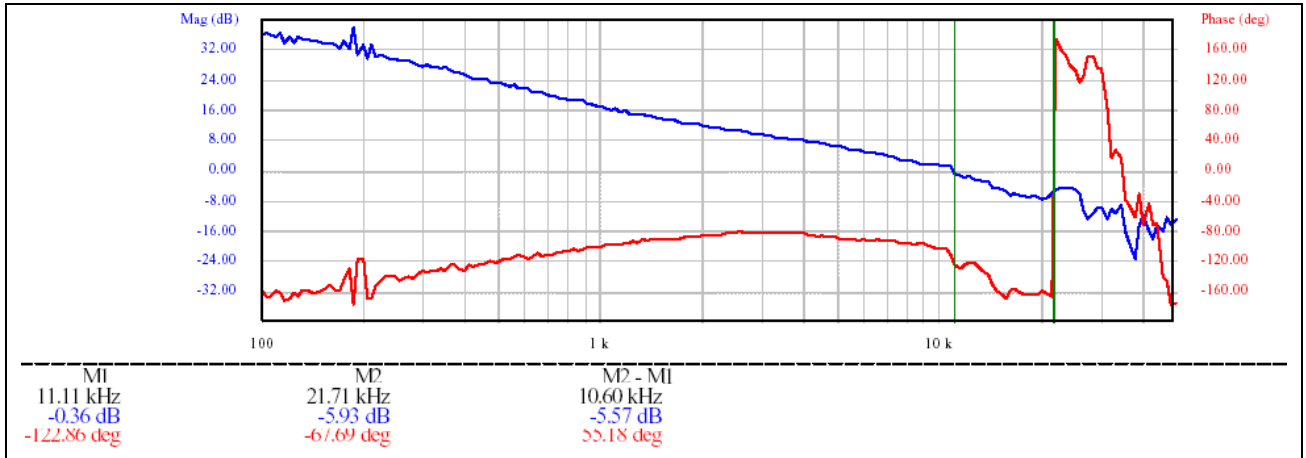

Figure 24 – Gain-Phase Plot, 240 VAC, Maximum Steady State Load
 Vertical Scale: Gain = 8 dB/div, Phase = 40 °/div.
 Crossover Frequency = 11.11 kHz Phase Margin = 57.14°

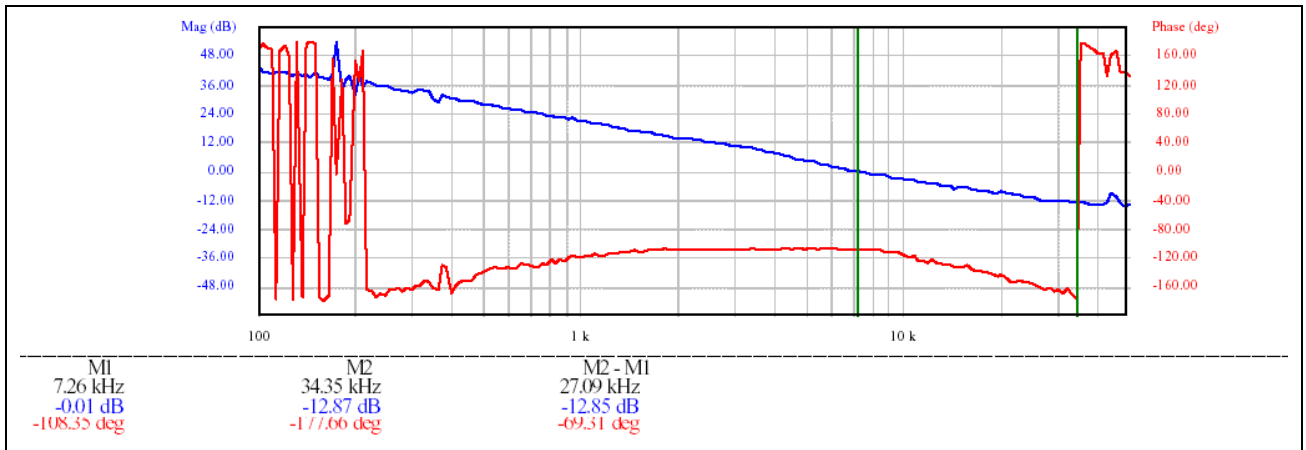

Figure 25 – Gain-Phase Plot, 240 VAC, 3A Load
 Vertical Scale: Gain = 12 dB/div, Phase = 40 °/div.
 Crossover Frequency = 7.26 kHz Phase Margin = 71.65°

12 Conducted EMI

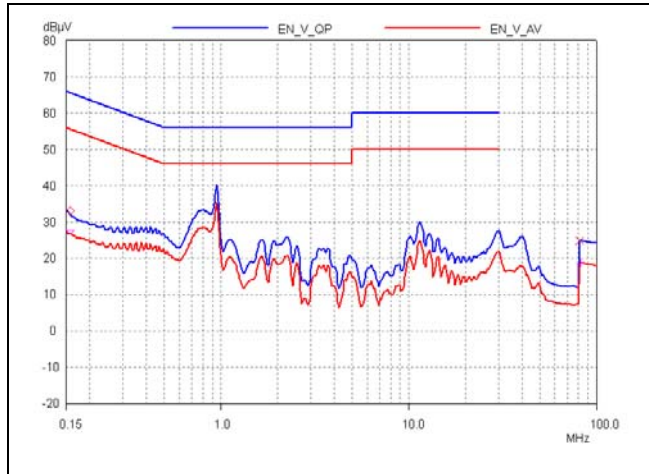

Figure 26 – Maximum Steady State Load, 120 VAC/60 Hz, and EN55022 B Limits (LINE)

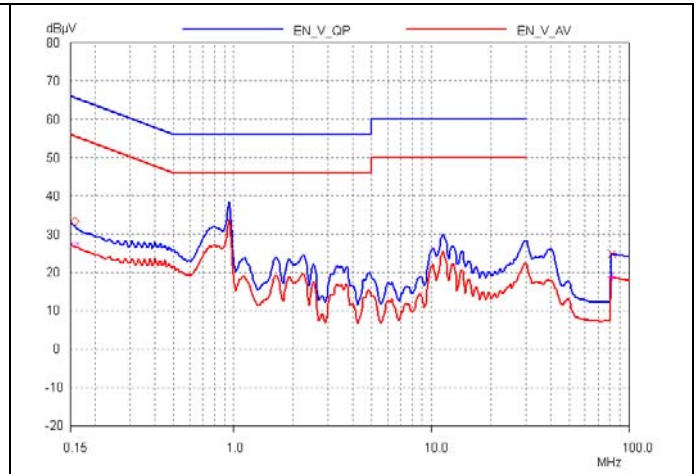

Figure 27 – Maximum Steady State Load, 120VAC/60 Hz, and EN55022 B Limits (Neutral)

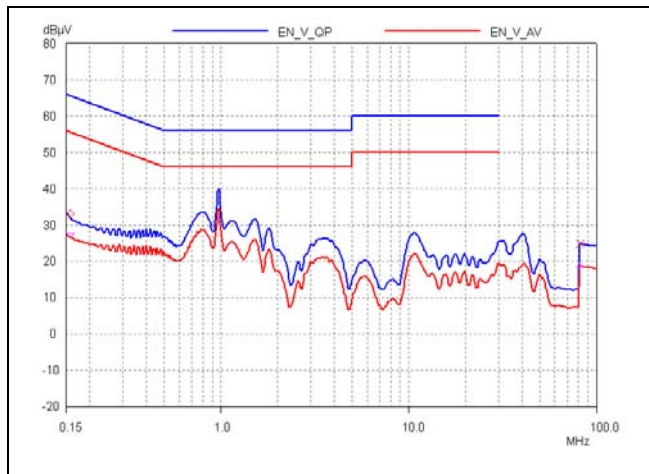

Figure 28 – Maximum Steady State Load, 240 VAC/60 Hz, and EN55022 B Limits (LINE)

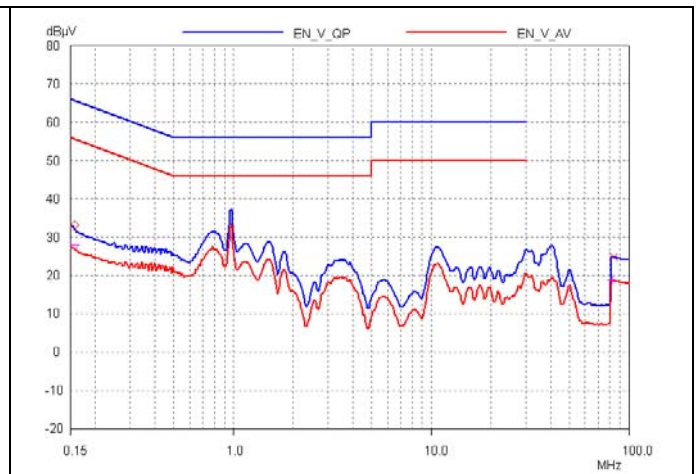

Figure 29 – Maximum Steady State Load, 240VAC/60 Hz, and EN55022 B Limits (Neutral)



13 Revision History

Date	Author	Revision	Description & changes	Reviewed
10-26-05	RSP	1.0	Initial Release	KM/JC/VC



For the latest updates, visit our website: www.powerint.com

Power Integrations reserves the right to make changes to its products at any time to improve reliability or manufacturability. Power Integrations does not assume any liability arising from the use of any device or circuit described herein. POWER INTEGRATIONS MAKES NO WARRANTY HEREIN AND SPECIFICALLY DISCLAIMS ALL WARRANTIES INCLUDING, WITHOUT LIMITATION, THE IMPLIED WARRANTIES OF MERCHANTABILITY, FITNESS FOR A PARTICULAR PURPOSE, AND NON-INFRINGEMENT OF THIRD PARTY RIGHTS.

PATENT INFORMATION

The products and applications illustrated herein (including transformer construction and circuits external to the products) may be covered by one or more U.S. and foreign patents, or potentially by pending U.S. and foreign patent applications assigned to Power Integrations. A complete list of Power Integrations' patents may be found at www.powerint.com. Power Integrations grants its customers a license under certain patent rights as set forth at <http://www.powerint.com/ip.htm>.

The PI Logo, **TOPSwitch**, **TinySwitch**, **LinkSwitch**, **DPA-Switch**, **EcoSmart**, **PI Expert** and **PI FACTS** are trademarks of Power Integrations, Inc. Other trademarks are property of their respective companies. ©Copyright 2005 Power Integrations, Inc.

Power Integrations Worldwide Sales Support Locations

WORLD HEADQUARTERS

5245 Hellyer Avenue
San Jose, CA 95138, USA.
Main: +1-408-414-9200
Customer Service:
Phone: +1-408-414-9665
Fax: +1-408-414-9765
e-mail: usasales@powerint.com

GERMANY

Rueckertstrasse 3
D-80336, Munich
Germany
Phone: +49-89-5527-3910
Fax: +49-89-5527-3920
e-mail: eurosales@powerint.com

JAPAN

Keihin Tatemono 1st Bldg
2-12-20
Shin-Yokohama, Kohoku-ku,
Yokohama-shi, Kanagawa ken,
Japan 222-0033
Phone: +81-45-471-1021
Fax: +81-45-471-3717
*e-mail:
japansales@powerint.com*

TAIWAN

5F, No. 318, Nei Hu Rd., Sec. 1
Nei Hu Dist.
Taipei, Taiwan 114, R.O.C.
Phone: +886-2-2659-4570
Fax: +886-2-2659-4550
*e-mail:
taiwansales@powerint.com*

CHINA (SHANGHAI)

Rm 807-808A,
Pacheer Commercial Centre,
555 Nanjing Rd. West
Shanghai, P.R.C. 200041
Phone: +86-21-6215-5548
Fax: +86-21-6215-2468
e-mail: chinasales@powerint.com

INDIA

261/A, Ground Floor
7th Main, 17th Cross,
Sadashivanagar
Bangalore, India 560080
Phone: +91-80-5113-8020
Fax: +91-80-5113-8023
e-mail: indiasales@powerint.com

KOREA

RM 602, 6FL
Korea City Air Terminal B/D,
159-6
Samsung-Dong, Kangnam-Gu,
Seoul, 135-728, Korea
Phone: +82-2-2016-6610
Fax: +82-2-2016-6630
*e-mail:
koreasales@powerint.com*

EUROPE HQ

1st Floor, St. James's House
East Street, Farnham
Surrey, GU9 7TJ
United Kingdom
Phone: +44 (0) 1252-730-140
Fax: +44 (0) 1252-727-689
e-mail: eurosales@powerint.com

CHINA (SHENZHEN)

Room 2206-2207, Block A,
Elec. Sci. Tech. Bldg.
2070 Shennan Zhong Rd.
Shenzhen, Guangdong,
China, 518031
Phone: +86-755-8379-3243
Fax: +86-755-8379-5828
e-mail: chinasales@powerint.com

ITALY

Via Vittorio Veneto 12
20091 Bresso MI
Italy
Phone: +39-028-928-6000
Fax: +39-028-928-6009
e-mail: eurosales@powerint.com

SINGAPORE

51 Newton Road,
#15-08/10 Goldhill Plaza,
Singapore, 308900
Phone: +65-6358-2160
Fax: +65-6358-2015
*e-mail:
singaporesales@powerint.com*

APPLICATIONS HOTLINE

World Wide +1-408-414-9660

APPLICATIONS FAX

World Wide +1-408-414-9760

