

CGRSD -③BMFA - SL8001

Specifications 型号说明



Material 材质 :

壳体材料: 阻燃抗 UV 尼龙+玻纤 UL94V-0 1/16"
 焊接式针孔: 黄铜; 簧: 镀青铜 镀金 4u"--20u"
 密封圈: 三元乙丙橡胶
 Connector Body: Nylon+GF UL94V-0 1/16"
 Contact: Brass C2680 and C17200 4u"--20u" Gold Plated
 Sealing: EPDM
 RoHS 环保材料 CE 认证

DESCRIPTION 说明	DETAILS 细节	CODE 编码
1 Connector Size 壳体号	WY-1031	S
2 Current Rating 额定电流	5A	D
③ Number of Contacts 接触对数	6,7,9	6,7,9
4 Connector Type 壳体类型	Without SR 不带网尾	B
5 Connector Gender 壳体性别	Male 公	M
6 Contact Gender 端子性别	Female 母	F
7 Assembly Style 组合设计款式	Field Installable(Solder) 现场安装式 (焊接)	A
⑧ Mating Style 配合设计款式	Screw 螺纹	S
9 Backs hell 壳体形状	Straight 直线	L
10 Waterproof Rating 防水等级	IP68	8
11 Version 版本		001

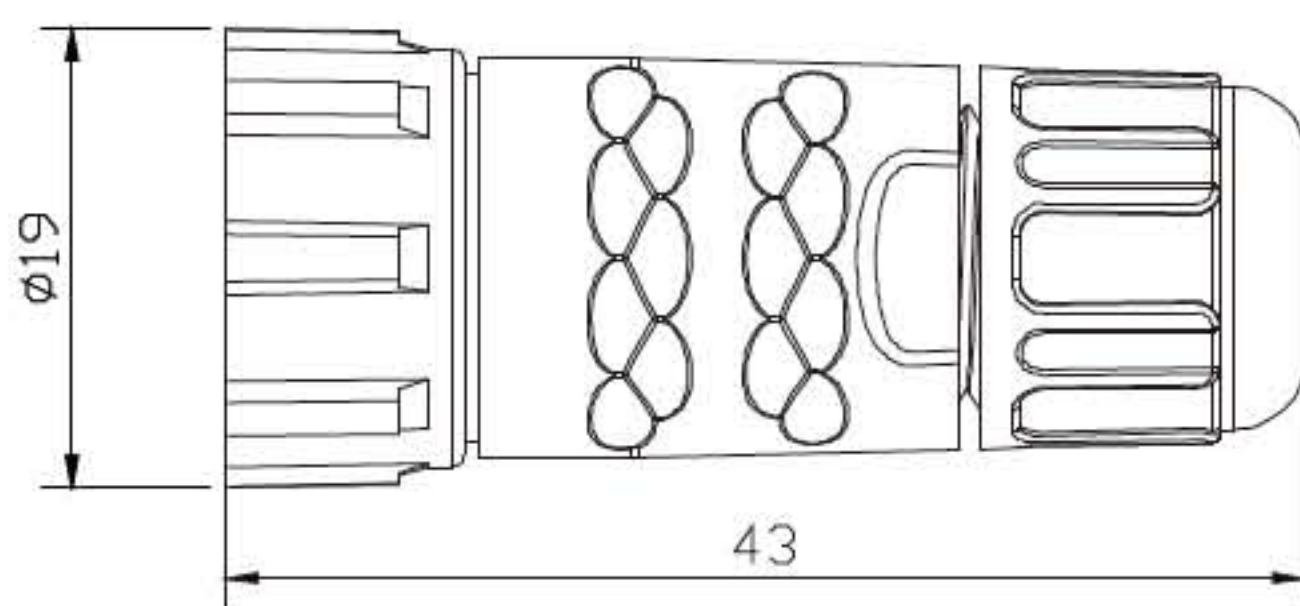

Contact Configurations 接触对型谱 :

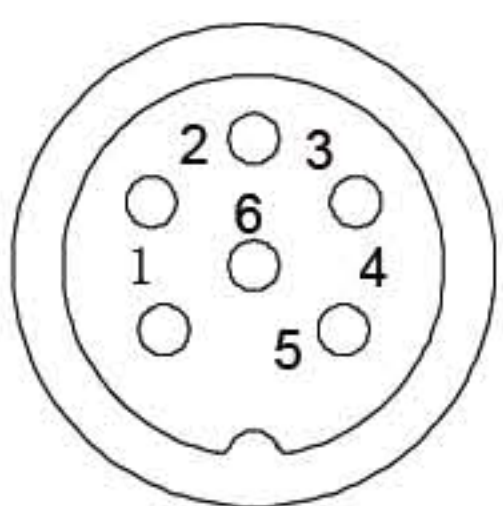

6pin

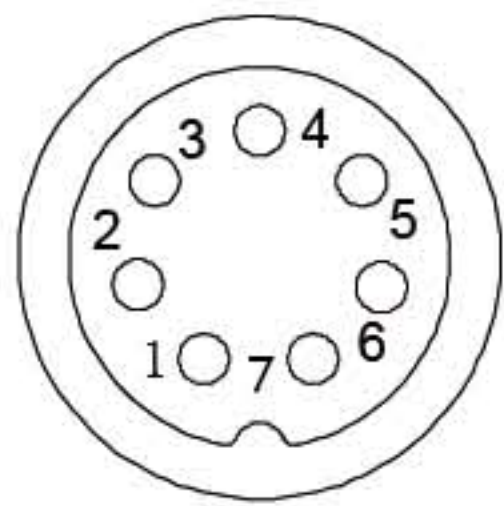

7pin

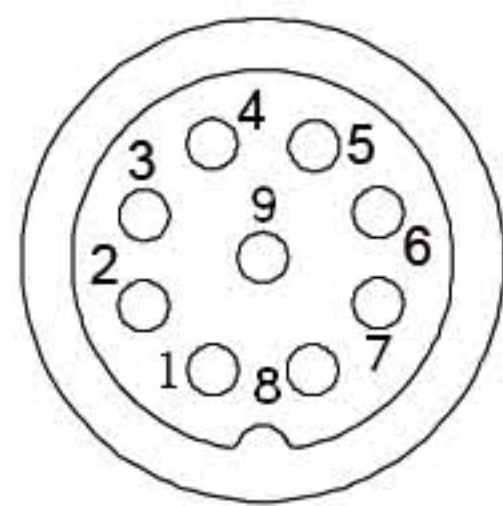

9pin

Mating Parts 配合件 :



CGRSD-6BMM⑦ -SC8001



CGRSD-6BFMA -SL8001



Waterproof Cover-C005 防护盖

How to buy? 怎样选型订购 ?

- * 确认您需要的接触对的电流和芯数 ?
- * 确认您需要的壳体和端子性别 ?
- * 确认是否自己焊接电缆 ?
- * 确认公母头配合的设计款式
- * 确认您使用的电缆的外径尺寸 ?
- * 是否需要防护盖 ?
- * confirming Current Rating and Number of Contacts
- * confirming Connector and Contact Gender
- * confirming Assembly Style
- * confirming Mating Style
- * confirming Cable OD Size
- * Need Waterproof Cover?

Property 性能

Contact Resistance 接触电阻	:<5mΩ
Insulation Resistance 绝缘电阻	:≥500 MΩ at DC500V
Breakdown Voltage 耐电压	:≥1000V/1Minute 常态下 2.5kV 水淋 1.0kV
Temperature Rating 工作温度范围	: -45°C~+105°C
Waterproof Rating 密封保护	:IP68 10m Water 2 weeks :10m 水深两周
Durability 耐插拔次数	: ≥ 3k Plug/Unplug Cycles 3 千次以上

CGRSD -③BFMA - SL8001

Specifications 型号说明



Material 材质:

壳体材料: 阻燃抗 UV 尼龙+玻纤 UL94V-0 1/16"

焊接式针孔: 黄铜; 簧: 镀青铜 镀金 4u"--20u"

密封圈: 三元乙丙橡胶

Connector Body: Nylon+GF UL94V-0 1/16"

Contact: Brass C2680 and C17200 4u"--20u" Gold Plated

Sealing: EPDM

RoHS 环保材料 CE 认证

DESCRIPTION 说明	DETAILS 细节	CODE 编码
1 Connector Size 壳体号	WY-1031	S
2 Current Rating 额定电流	5A	D
③ Number of Contacts 接触对数	6,7,9	6,7,9
4 Connector Type 壳体类型	Without SR 不带网尾	B
5 Connector Gender 壳体性别	Female 母	F
6 Contact Gender 端子性别	Male 公	M
7 Assembly Style 组合设计款式	Field Installable(Solder) 现场安装式(焊接)	A
8 Mating Style 配合设计款式	Screw 螺纹	S
9 Backs hell 壳体形状	Straight 直线	L
10 Waterproof Rating 防水等级	IP68	8
11 Seals for Cable OD Version 适配线缆外径版本	Φ3mm~Φ7mm Φ7mm~Φ11mm	001 002

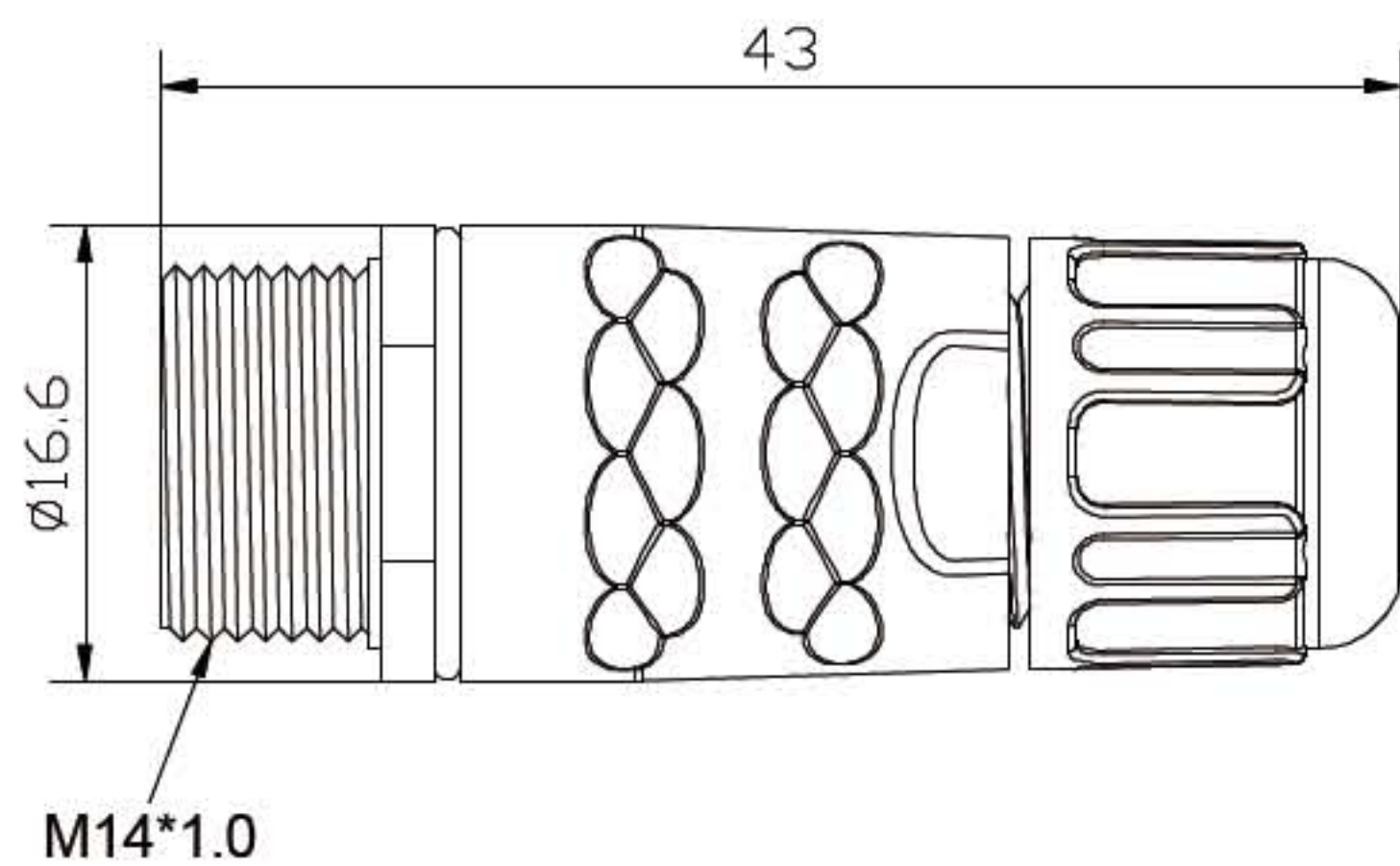

How to buy? 怎样选型订购?

- * 确认您需要的接触对的电流和芯数?
- * 确认您需要的壳体和端子性别?
- * 确认是否自己焊接电缆?
- * 确认公母头配合的设计款式
- * 确认您使用的电缆的外径尺寸?
- * 是否需要防护盖?
- * confirming Current Rating and Number of Contacts
- * confirming Connector and Contact Gender
- * confirming Assembly Style
- * confirming Mating Style
- * confirming Cable OD Size
- * Need Waterproof Cover?

Contact Configurations 接触对型谱:

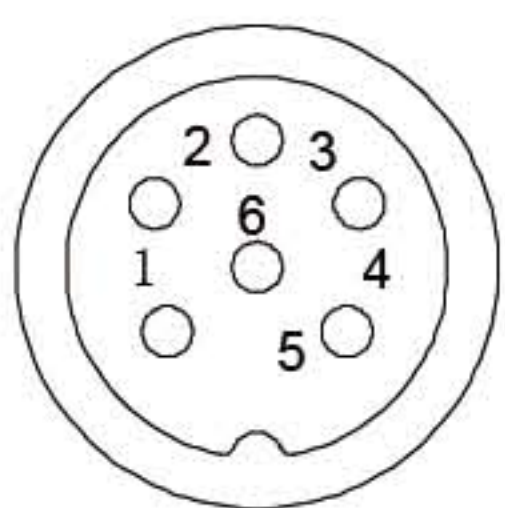

6pin

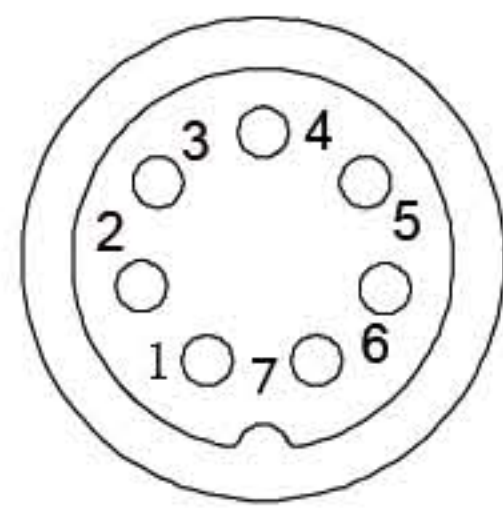

7pin

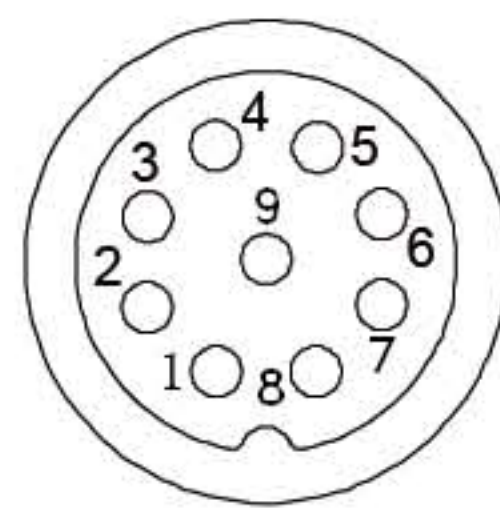

9pin

Mating Parts 配合件:



CGRSD-6BMFA -SL8001



Waterproof Cover-C004 防护盖

Property 性能

Contact Resistance 接触电阻	:<5mΩ
Insulation Resistance 绝缘电阻	:≥500 MΩ at DC500V
Breakdown Voltage 耐电压	:≥1000V/1Minute 常态下 2.5kV 水淋 1.0kV
Temperature Rating 工作温度范围	: -45℃~+105℃
Waterproof Rating 密封保护	: IP68 10m Water 2 weeks :10m 水深两周
Durability 耐插拔次数	: ≥ 3k Plug/Unplug Cycles 3 千次以上

CGRSB-③BMFA -SL8001

Specifications 型号说明



Material 材质:

壳体材料: 阻燃抗 UV 尼龙+玻纤 UL94V-0 1/16"
 焊接式针孔: 黄铜; 簧: 镀青铜 镀金 4u"--20u"
 密封圈: 三元乙丙橡胶
 Connector Body: Nylon+GF UL94V-0 1/16"
 Contact: Brass C2680 and C17200 4u"--20u" Gold Plated
 Sealing: EPDM
 RoHS 环保材料 CE 认证

DESCRIPTION 说明	DETAILS 细节	CODE 编码
1 Connector Size 壳体号	WY-1031	S
2 Current Rating 额定电流	10A	B
③ Number of Contacts 接触对数	2,3,4	2,3,4
4 Connector Type 壳体类型	Without SR 不带网尾	B
5 Connector Gender 壳体性别	Male 公	M
6 Contact Gender 端子性别	Female 母	F
7 Assembly Style 组合设计款式	Field Installable(Solder) 现场安装式(焊接)	A
8 Mating Style 配合设计款式	Screw 螺纹	S
9 Backs hell 壳体形状	Straight 直线	L
10 Waterproof Rating 防水等级	IP68	8
11 Version 版本		001

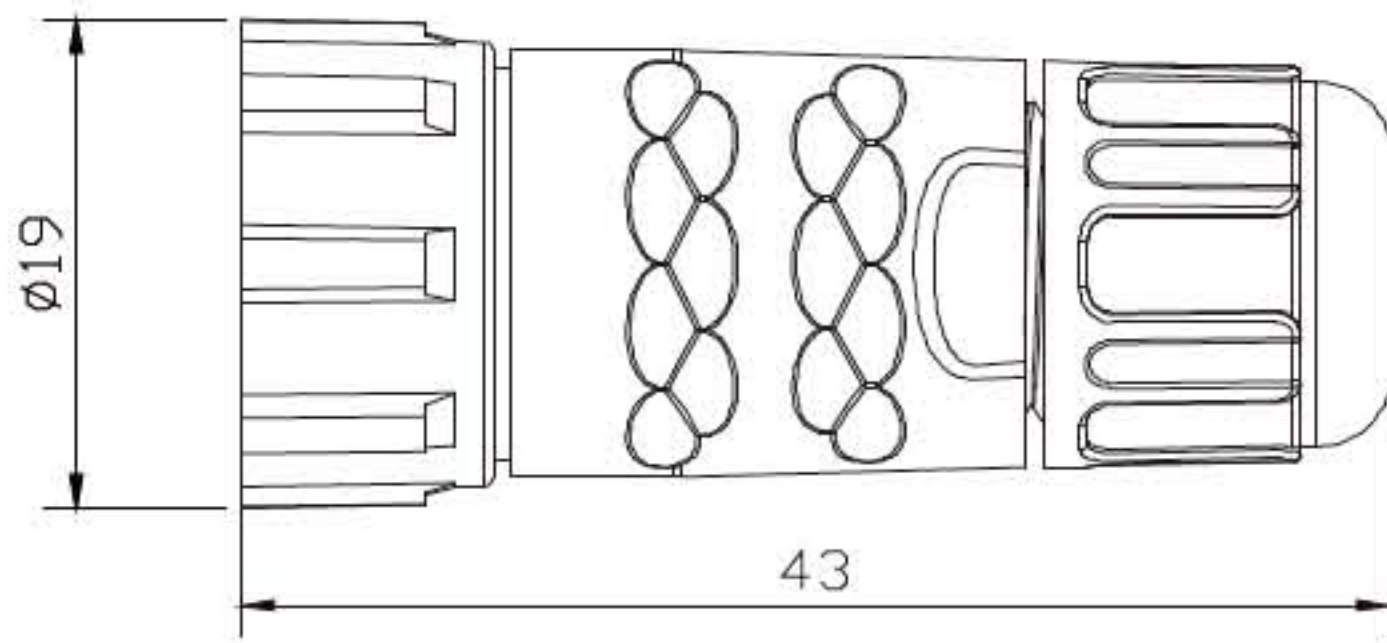

Contact Configurations 接触对型谱:

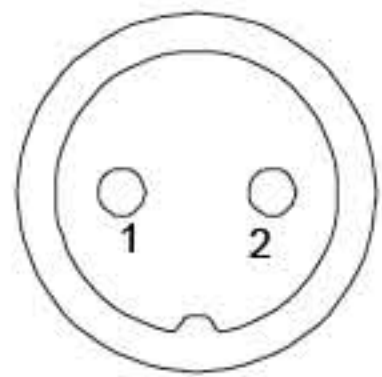

2pin

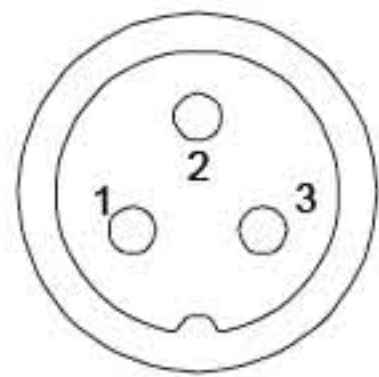

3pin

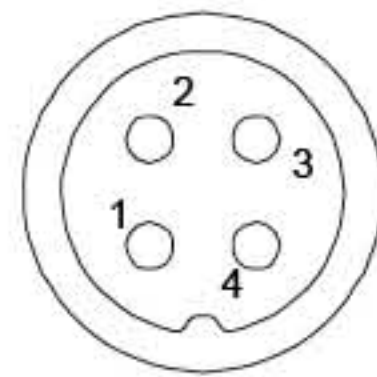

4pin

Mating Parts 配合件:



CGRSD-③BMM⑦ -SC8001



CGRSD-③BFMA -SL8001



Waterproof Cover-C005 防护盖

How to buy? 怎样选型订购?

- * 确认您需要的接触对的电流和芯数?
- * 确认您需要的壳体和端子性别?
- * 确认是否自己焊接电缆?
- * 确认公母头配合的设计款式
- * 确认您使用的电缆的外径尺寸?
- * 是否需要防护盖?
- * confirming Current Rating and Number of Contacts
- * confirming Connector and Contact Gender
- * confirming Assembly Style
- * confirming Mating Style
- * confirming Cable OD Size
- * Need Waterproof Cover?

Property 性能

Contact Resistance 接触电阻	:<5mΩ
Insulation Resistance 绝缘电阻	:≥500 MΩ at DC500V
Breakdown Voltage 耐电压	:≥1000V/1Minute 常态下 2.5kV 水淋 1.0kV
Temperature Rating 工作温度范围	: -45°C~+105°C
Waterproof Rating 密封保护	:IP68 10m Water 2 weeks :10m 水深两周
Durability 耐插拔次数	:≥ 3k Plug/Unplug Cycles 3 千次以上

CGRSB-③BFMA -SL8001

Specifications 型号说明



Material 材质:

壳体材料: 阻燃抗 UV 尼龙+玻纤 UL94V-0 1/16"
 焊接式针孔: 黄铜; 簧: 镀青铜 镀金 4u"--20u"
 密封圈: 三元乙丙橡胶
 Connector Body: Nylon+GF UL94V-0 1/16"
 Contact: Brass C2680 and C17200 4u"--20u" Gold Plated
 Sealing: EPDM
 RoHS 环保材料 CE 认证

DESCRIPTION 说明	DETAILS 细节	CODE 编码
1 Connector Size 壳体号	WY-1031	S
2 Current Rating 额定电流	10A	B
③ Number of Contacts 接触对数	2,3,4	2,3,4
4 Connector Type 壳体类型	Without SR 不带网尾	B
5 Connector Gender 壳体性别	Female 母	F
6 Contact Gender 端子性别	Male 公	M
7 Assembly Style 组合设计款式	Field Installable(Solder) 现场安装式(焊接)	A
8 Mating Style 配合设计款式	Screw 螺纹	S
9 Backs hell 壳体形状	Straight 直线	L
10 Waterproof Rating 防水等级	IP68	8
11 Version 版本		001

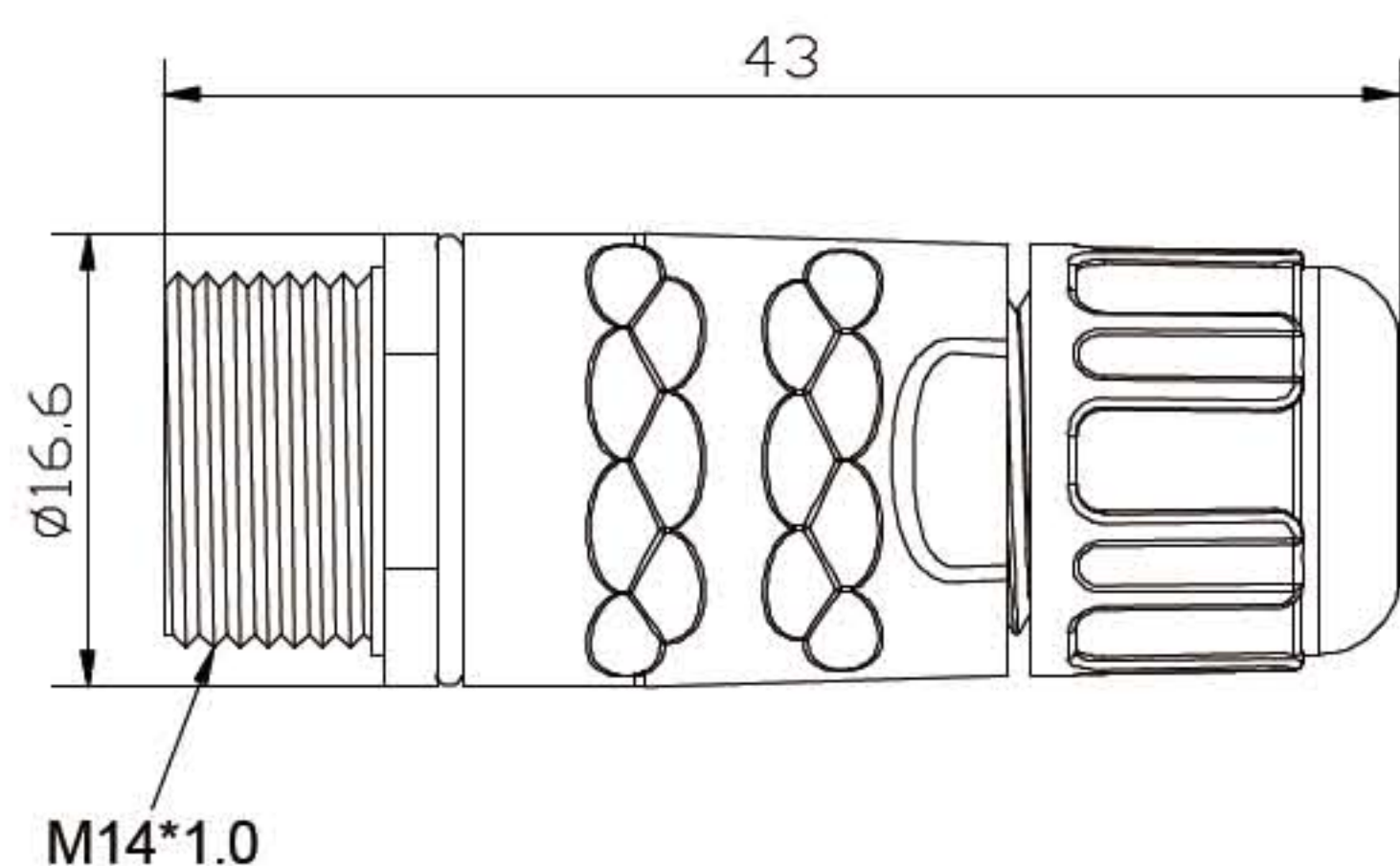

How to buy? 怎样选型订购?

- * 确认您需要的接触对的电流和芯数?
- * 确认您需要的壳体和端子性别?
- * 确认是否自己焊接电缆?
- * 确认公母头配合的设计款式
- * 确认您使用的电缆的外径尺寸?
- * 是否需要防护盖?
- * confirming Current Rating and Number of Contacts
- * confirming Connector and Contact Gender
- * confirming Assembly Style
- * confirming Mating Style
- * confirming Cable OD Size
- * Need Waterproof Cover?

Contact Configurations 接触对型谱:

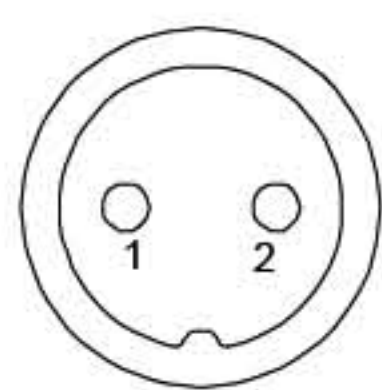

2pin

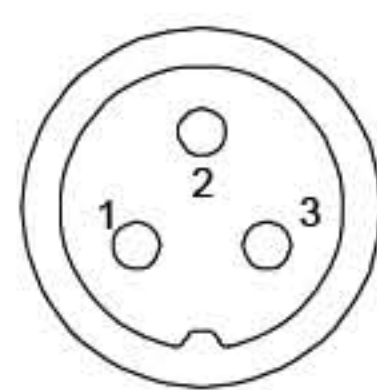

3pin

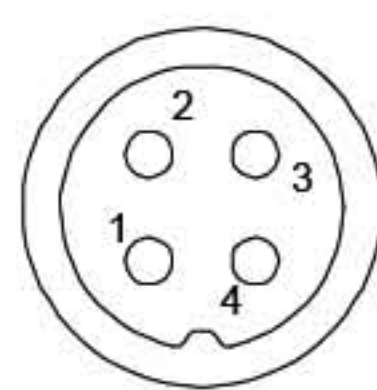

4pin

Mating Parts 配合件:



CGRSB-③BMFA -SL8001

Waterproof Cover-C004 防护盖

Property 性能

Contact Resistance 接触电阻	:<5mΩ
Insulation Resistance 绝缘电阻	:≥500 MΩ at DC500V
Breakdown Voltage 耐电压	:≥1000V/1Minute 常态下 2.5kV 水淋 1.0kV
Temperature Rating 工作温度范围	: -45℃~+105℃
Waterproof Rating 密封保护	: IP68 10m Water 2 weeks :10m 水深两周
Durability 耐插拔次数	: ≥ 3k Plug/Unplug Cycles 3 千次以上