

LED 大功率芯片外观全集

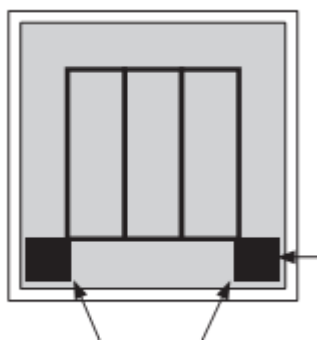

美国-CREE



美国- Semileds - 旭明

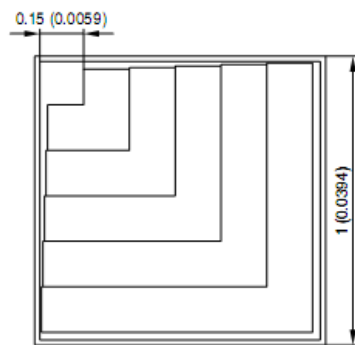

德国- Osram (欧司朗)

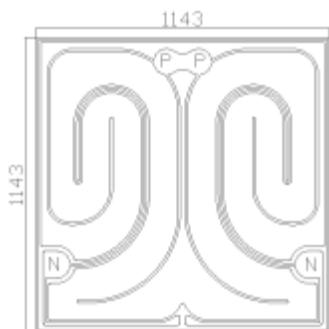

美国- Bridgelux (普瑞) BXC 版本

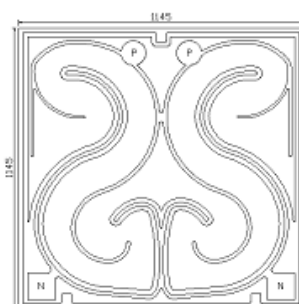

美国- Bridgelux MKO 版本



美国- Bridgelux 最新版本

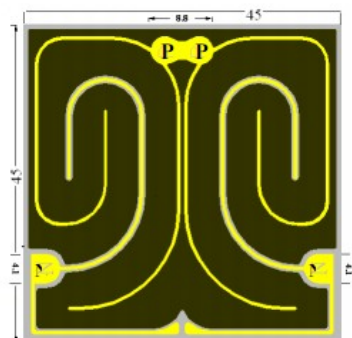

台湾- Epistar (晶元)

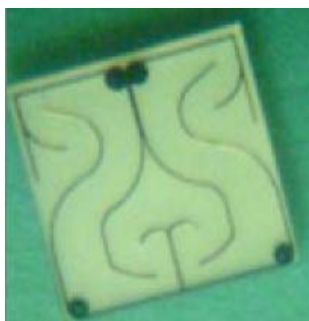

台湾- Epistar (晶元 45mil)



台湾- Epistar (晶元 50mil)

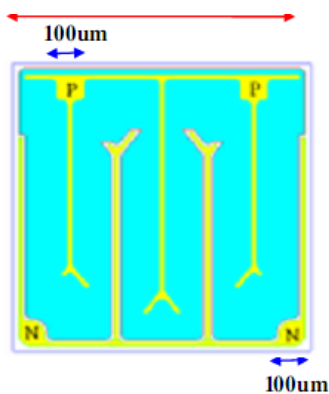

台湾- Epileds (光鉍, EL)

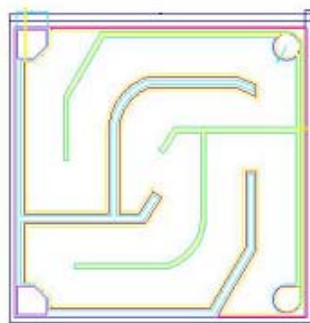

台湾- Tekcore (泰谷 40mil)

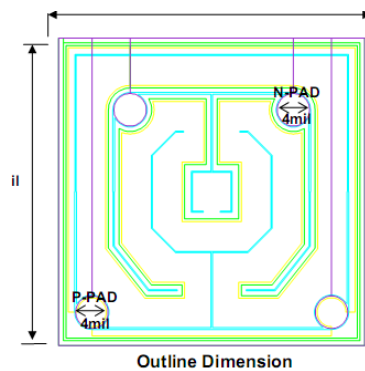

韩国- EC (安盈, EC40mil)

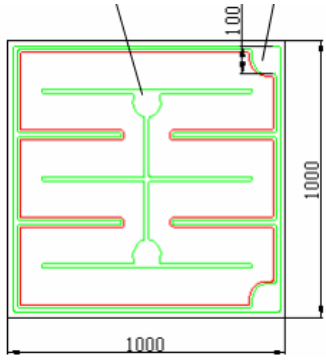

台湾- Forepi (璨圆, 40mil)

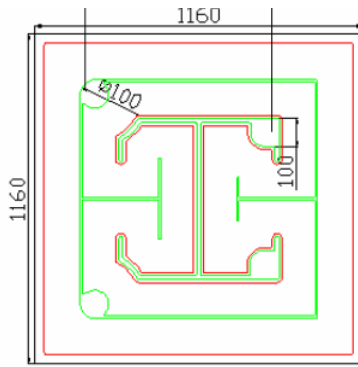

台湾- Forepi (璨圆, 45mil)

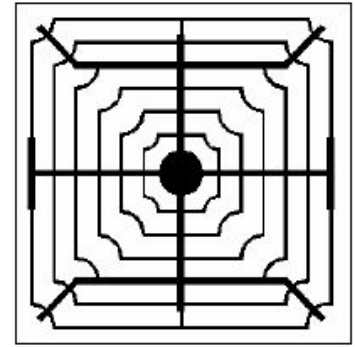

台湾- 联胜

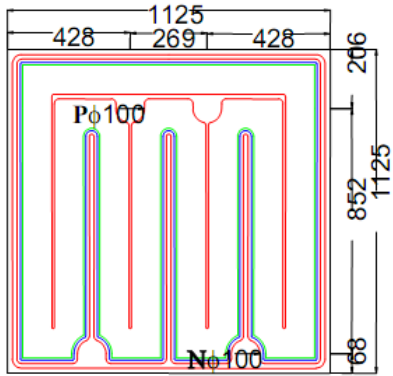

台湾- 旭晶

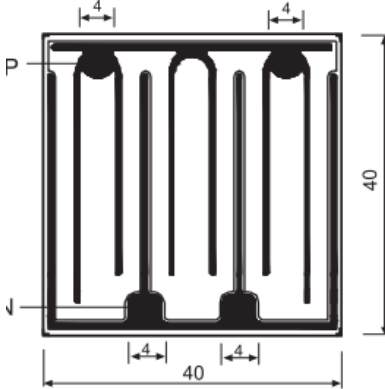

中国- Sanan (厦门, 三安)

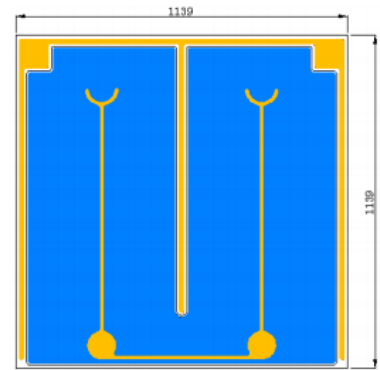

中国- (武汉, 迪源)

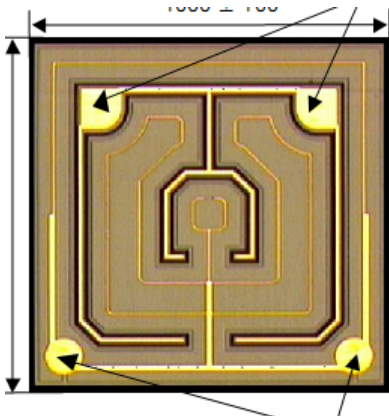

韩国- Optoway (欧谱特威, OBL)



香港- APT (晶科)

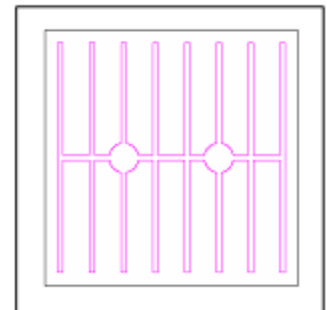

台湾- (全新, VPEC)



台湾- (新世纪)

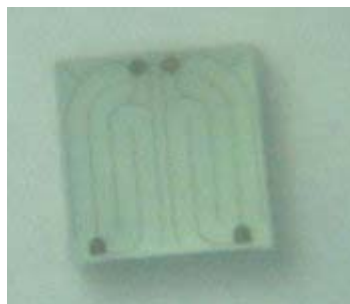

台湾- 奇力



台湾- AOC (华上)